

MID SUSSEX DISTRICT COUNCIL

# Mid Sussex Design Guide

Supplementary Planning  
Document SPD

**Adopted**

November 2020





# CONTENTS

<b>01 Purpose of the Design Guide</b> .....	<b>5</b>	<b>05 Site Optimisation and Mixed Use Layouts</b> .....	<b>81</b>
1.1 Overall Objectives and Status of the Guide.....	6	5.1 Planning for Increased Density.....	82
1.2 Sustainability Objectives .....	6	5.2 Town Centre Intensification .....	83
1.3 Who is the Guide for?.....	7	5.3 Optimising the Development Potential of Urban Extensions	87
1.4 Understanding Planning Policy and Guidance.....	8	5.4 Mix of Uses.....	89
1.5 Structure of the Guide.....	9	Checklist.....	91
1.6 Opportunities and Constraints.....	14	<b>06 High Quality and Sustainable Building Design</b> .....	<b>93</b>
1.7 The Value of Good Design .....	15	6.1 Introduction .....	94
1.8 The Design Process.....	16	6.2 Sustainable Buildings.....	94
1.9 Who to Talk to .....	17	6.3 Delivering Architectural Integrity and Sense of Place.....	96
<b>02 Understanding the Context</b> .....	<b>19</b>	6.4 Height and Scale.....	104
2.1 Introduction .....	20	6.5 Designing Buildings with Active Frontages.....	106
2.2 Overview of the District .....	21	6.6 Designing Buildings on Sloping Sites .....	110
2.3 Character Study.....	24	6.7 Accommodating Services .....	111
2.4 Landscape Character.....	25	Checklist.....	112
2.5 Settlement Character .....	28	<b>07 Business Parks / Employment Areas</b> .....	<b>115</b>
2.6 Mid Sussex's Town Centres .....	31	7.1 Introduction.....	116
2.7 Site Appraisal.....	38	7.2 Layout of New Employment Areas .....	116
Checklists .....	39	7.3 Design of Commercial Buildings .....	118
<b>03 Establishing the Structure</b> .....	<b>43</b>	Checklist.....	119
3.1 Introduction .....	44	<b>08 Residential Amenity</b> .....	<b>121</b>
3.2 Natural Resources .....	44	8.1 Introduction .....	122
3.3 Movement Network.....	50	8.2 Privacy.....	122
3.4 Existing Townscape and Heritage.....	53	8.3 External Amenity Space .....	123
Checklist.....	55	8.4 Daylight / Sunlight .....	124
<b>04 Site Layout, Streets and Spaces</b> .....	<b>57</b>	8.5 Noise, Air and Light Pollution .....	124
4.1 Introduction .....	58	Checklist.....	125
4.2 Urban Structure - Perimeter Block.....	58	<b>09 Household Extensions</b> .....	<b>127</b>
4.3 Urban Structure - Positive Frontages .....	60	9.1 Introduction .....	128
4.4 Urban Structure - Enclosure .....	61	9.2 Design Principles .....	129
4.5 Legibility and Image .....	62	Checklist.....	133
4.6 Pedestrian Friendly Streets / Street Hierarchy.....	64	<b>10 Building Conversions</b> .....	<b>135</b>
4.7 Parking.....	66	10.1 Introduction .....	138
4.8 Refuse, Storage and Utilities .....	69	10.2 Conversions of Traditional Buildings with Heritage Value	136
4.9 Open Space and Public Realm .....	72	10.3 Office to Residential Conversions.....	138
Checklist.....	78	Checklist.....	139
		<b>Glossary</b> .....	<b>140</b>



# 1 Purpose of the Design Guide



# 1 Purpose of the Design Guide Objectives and Status



## 1.1 Overall Objectives and Status of the Guide

1.1.1 The Mid Sussex Design Guide provides clear design principles that aim to deliver high quality new development across Mid Sussex that is inclusive and responds appropriately to its context while prioritising sustainability in the design process. These principles are based on the policy framework provided by District Plan Policy DP26: Character and Design.

1.1.2 This Design Guide is intended to inform and guide the quality of design for all development across the District. Its main focus is larger schemes (urban extensions or proposals on brownfield sites), however it is also relevant for proposals for a single house, for a household extension or building conversion.

1.1.3 The Guide puts forward principles and standards for new development that aim to create safe and attractive places that are sensitive to Mid Sussex's special character while also allowing creative and innovative design solutions.

1.1.4 High quality design is essential to optimise the development potential of sites and to deliver the kind of places that will provide economic and environmental well-being and quality of life for the District's residents both now and into the future.

1.1.5 The Design Guide has been adopted as Supplementary Planning Document (SPD) and provides further detail to District Plan Policy DP26: Character and Design. As an SPD it is a material consideration in the determination of planning applications.

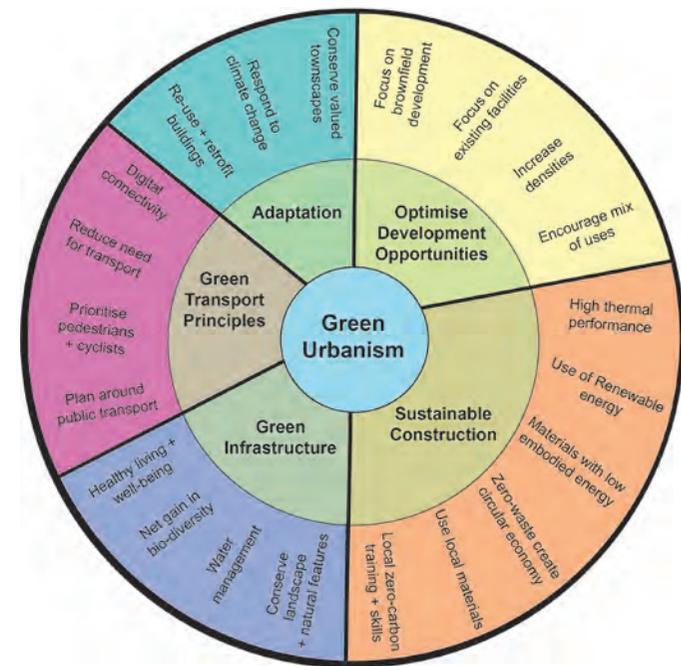

Figure 1A: Sustainability issues that should be considered when designing new development (MSDC)

## 1.2 Sustainability Objectives

1.2.1 All new development should be designed to high environmental standards. This applies to both the building design and layout which should have regard to the following:

- Sustainable construction principles including maximising energy and water efficiency, minimising carbon emissions and use of resources;
- Optimising development opportunities especially on brownfield sites and in locations close to facilities or with good transport links;
- Organising development around green transport principles that reduce travel distances, prioritise pedestrian and cycle movement and integrate public transport;
- Planning schemes around Green Infrastructure provision that is underpinned by: (a) healthy living and well-being principles; (b) helping to deliver a net gain in bio-diversity; (c) responding to the beauty of the natural landscape and ensuring that natural features are retained and enhanced; and
- Designing for adaptation and resilience to future weather events (drier/hotter summers and wetter/warmer winters).

# 1 Purpose of the Design Guide

## A User-friendly Guide



### 1.3 Who is the Guide for?

1.3.1 This Design Guide is intended for frequent reference and will be essential for anyone charged with preparing or assessing the quality of planning applications including:

- Developers and builders, in considering potential development proposals;
- Householders, considering residential extensions;
- Design professionals, in drawing up schemes for development;
- Town and parish councils, statutory and non-statutory consultees and the public in commenting on planning applications; and
- The District Council, in determining planning applications and in upholding decisions at planning appeals.

***“A thriving and attractive District, a desirable place to live, work and visit. Our aim is to maintain, and where possible, improve the social, economic and environmental well-being of our District and the quality of life for all, now and in the future.”***

Mid Sussex District Council Vision from District Plan

### DP26: Character and Design

**Strategic Objectives:** 2) To promote well located and designed development that reflects the District’s distinctive towns and villages, retains their separate identity and character and prevents coalescence; 4) To protect valued characteristics of the built environment for their historical and visual qualities; 12) To support sustainable communities which are safe, healthy and inclusive; and 14) To create environments that are accessible to all members of the community.

All development and surrounding spaces, including alterations and extensions to existing buildings and replacement dwellings, will be well designed and reflect the distinctive character of the towns and villages while being sensitive to the countryside. All applicants will be required to demonstrate that development:

- is of high quality design and layout and includes appropriate landscaping and greenspace;
- contributes positively to, and clearly defines, public and private realms and should normally be designed with active building frontages facing streets and public open spaces to animate and provide natural surveillance;
- creates a sense of place while addressing the character and scale of the surrounding buildings and landscape;
- protects open spaces, trees and gardens that contribute to the character of the area;
- protects valued townscapes and the separate identity and character of towns and villages;
- does not cause significant harm to the amenities of existing nearby residents and future occupants of new dwellings, including taking account of the impact on privacy, outlook, daylight and sunlight, and noise, air and light pollution (see Policy DP29);
- creates a pedestrian-friendly layout that is safe, well connected, legible and accessible;
- incorporates well integrated parking that does not dominate the street environment, particularly where high density housing is proposed;
- positively addresses sustainability considerations in the layout and the building design;
- take the opportunity to encourage community interaction by creating layouts with a strong neighbourhood focus/centre; larger (300+ unit) schemes will also normally be expected to incorporate a mixed use element; and
- optimises the potential of the site to accommodate development.

Figure 1B: Local Plan Policy DP26: Character and Design

# 1 Purpose of the Design Guide

## A User-friendly Guide

### 1.4 Understanding the Planning and Policy Context

1.4.1 National and local planning policies will influence whether a site is suitable for development and the form and nature of this development.

1.4.2 The Development Plan for the District is the **Mid Sussex District Plan** and **Neighbourhood Plans**, which cover most of the District.

1.4.3 There are also other supporting policy or strategy documents that may relate to a site. These may include Supplementary Planning Documents, Conservation Area Appraisals, the High Weald Housing Design Guide and Village Design Guides, which have been adopted or endorsed by the Council.

1.4.4 The guidelines incorporate as appropriate the MSDC Dormer Window and Rooflight Design Guidance (now superseded) under chapter 6 (section 6.3.5 to 6.3.8) and chapter 9 (section 9.2 / DG52).

1.4.5 Details of documents endorsed or adopted by the Council are available on the Council's website at <https://www.midsussex.gov.uk>

1.4.6 National Planning policies and guidance is available on the Gov.UK website. This includes:

- The **National Planning Policy Framework** which incorporates design guidance principally in section 7: "Achieving well-designed places"; and
- The **National Design Guide** which recognises that specific, detailed and measurable criteria for good design is most appropriately set out at the local level.

1.4.7 The National Design Guide outlines ten characteristics that contribute to good design. These are listed below and indicated in the diagram in Figure 1C.

1. **Context** – enhances the surroundings.
2. **Identity** – attractive and distinctive.
3. **Built form** – a coherent pattern of development.
4. **Movement** – accessible and easy to move around.
5. **Nature** – enhanced and optimised.
6. **Public spaces** – safe, social and inclusive.



Figure 1C: The ten characteristics of a well designed place (National Design Guide 2019)

7. **Uses** – mixed and integrated.
8. **Homes and buildings** – functional, healthy and sustainable.
9. **Resources** – efficient and resilient.
10. **Lifespan** – made to last.

#### Additional resources:

- National Design Guide (2019)
- Building for Life 12, The Sign of a good place to live (Cabe at the Design Council, Design for Homes and Home Builders Federation)
- Urban Design Compendium 1 (3rd edition, HCA and Studio REAL, 2013)

# 1 Purpose of the Design Guide

## A User-friendly Guide

### 1.5 Structure of the Guide

#### Design Guide Structure

1.5.1 The Design Guide is structured in ten chapters and Figure 1D sets out the design principles that relate to each of these and identifies the development types to which each principle is relevant. The ten National Design Guide characteristics are also cross-referenced with the Design Guide principles.

#### Design Principles

1.5.2 Each chapter is structured around Design Principles that new development should normally follow. The principles are drawn from best practice, respond to the unique environment within the District and are intended to guide and assist applicants on the design aspects that should normally be considered and addressed when drawing up their proposals.

1.5.3 This Design Guide provides general guidance on the form that new development should take. This addresses a range of development types including:

- New urban extensions and large residential developments;
- Brownfield and urban infill sites;
- New dwelling design;
- Household extensions;
- Building conversions; and
- Employment and commercial developments.

1.5.4 Not all principles will be relevant for smaller scale development proposals (including for single dwellings, household extensions or building conversions). Chapters three and four are most relevant for larger sites which must establish their own structure, either as part of an existing settlement or as an extension to an existing settlement.

1.5.5 The design principles are supported by illustrations and photographs of best practice examples including case studies from both within the District and elsewhere. Poor practice is also illustrated.

#### Checklists

1.5.6 Checklists are provided at the end of each chapter in the guide. The checklists are intended to act as prompts to applicants to ensure that the issues raised are considered at the right stage of the design process and to optimise the potential of the site to accommodate appropriate development.

1.5.7 Not all checklists or all the issues raised in individual checklists will apply to every site and each case will be decided on its merits.

1.5.8 Applicants are expected to demonstrate compliance where checklists do apply or robustly justify their proposals where a different approach has been taken.

# 1 Purpose of the Design Guide

## A User-friendly Guide

Design Guide Chapter	Design Principles	National Design Guide Characteristics	DEVELOPMENT TYPES						
			Large, medium and small residential developments (2 to 300+ dwellings)	Brownfield and urban infill	Commercial or employment	Mixed use scheme	Individual houses	Household extensions	Building conversions
2 Understanding the Context	DG1: Character Study	1/2							
	DG2: Site appraisal	1/2							
3 Establishing the Structure	DG3: Work with the site's natural features and resources	1/2/5							
	DG4: Establish a landscape and green infrastructure network	2/5/6							
	DG5: Water features and sustainable drainage systems	2/5/6/9							
	DG6: Design to enhance biodiversity	1/2/5/6							
	DG7: Respond to topography and strategic views	1/2							
	DG8: Establish a clear movement network that connects with the surrounding area	1/4							
	DG9: Reduce reliance on the private car	4/9							
	DG10: Anticipate future development	10							
	DG11: Respond to the existing townscape, heritage assets and historic landscapes	1/2							
	4 Site Layout, Streets and Spaces	DG12: Deliver a clear and connected structure of streets and spaces	4/6						
DG13: Provide positive frontage to streets		2/3/8							
DG14: Provide enclosure		2/3/8							
DG15: Use markers, landmarks, vistas and street hierarchy to aid legibility		2/3/4							
DG16: Create a positive development edge		1/2/3/10							
DG17: Provide attractive streets and spaces defined by buildings rather than the highway, that encourage low speeds and that are safe to use by everyone		2/3/4							

Figure 1D: Table setting out the structure of the design guide, the design principles and the type of developments to which they are broadly applicable

# 1 Purpose of the Design Guide

## A User-friendly Guide

Design Guide Chapter	Design Principles	National Design Guide Characteristics	DEVELOPMENT TYPES						
			Large, medium and small residential developments (2 to 300+ dwellings)	Brownfield and urban infill	Commercial or employment	Mixed use scheme	Individual houses	Household extensions	Building conversions
4 Site Layout, Streets and Spaces (cont.)	DG18: Integrate parking to support attractive streets and spaces	4							
	DG19: Provision of off-street parking	4							
	DG20: Integrate on-street parking	4							
	DG21: Consider and allow for servicing, refuse collection and deliveries	4/8							
	DG22: Integrate refuse and recycling into the design of new development	4/8/9							
	DG23: Integrate sub-stations, utilities and pump stations into the design	4/8/9							
	DG24: Plan for cyclists	4/8/9							
	DG25: Enhance the environment and sense of place through open spaces	2/3/6/8/10							
	DG26: Integrate space for play into the design	5/6/8							
	DG27: Integrate tree planting and soft landscape	2/5/6/10							
	DG28: Recommended tree species	2/5/6/10							
	DG29: Deliver a coordinated public realm with high quality landscape	2/5/6/10							
	DG30: Design for everyone and look to the future	7/8/9/10							
	5 Site Optimisation and Mixed Use	DG31: Focus development in sustainable locations	2/3/9						
DG32: Managing increased density in town centres		2/3/9							
DG33: Potential for tall buildings (over 6 storeys)		2/3/9							
DG34: Managing increased density in urban extensions		2/3/9							

Figure 1D (Part 2 continued): Table setting out the design guide principles and the type of developments to which they are broadly applicable

# 1 Purpose of the Design Guide

## A User-friendly Guide

Design Guide Chapter	Design Principles	National Design Guide Characteristics	DEVELOPMENT TYPES						
			Large, medium and small residential developments (2 to 300+ dwellings)	Brownfield and urban infill	Commercial or employment	Mixed use scheme	Individual houses	Household extensions	Building conversions
<b>5 Site Optimisation and Mixed Use (cont.)</b>	DG35: Promote a mix of uses within larger schemes to provide services to meet local needs, conveniently located where they are most accessible	7							
	DG36: Create mixed communities and housing that is adaptable to change	7/10							
<b>6 High Quality and Sustainable Building Design</b>	DG37: Deliver high quality buildings that minimise their environmental impact	8/9/10							
	DG38: Design buildings with architectural integrity and a sense of place	1/2/3/8							
	DG39: Deliver appropriately scaled buildings	2/3							
	DG40: Design buildings that respond to and animate the street space	2/3/8							
	DG41: Addressing sloping sites	2/3/8							
	DG42: Consider the location and design of services and external pipes	2/3/8							
<b>7 Business Parks / Employment Areas</b>	DG43: Deliver attractive and clearly laid-out employment areas that are sensitive to their surrounds	1/2/3/4							
	DG44: Design of commercial buildings	3/9/10							
<b>8 Residential Amenity</b>	DG45: Privacy of existing and future residents	8							
	DG46: Provide attractive and usable external amenity space for all homes	8							
	DG47: Provide homes with sufficient daylight and sunlight	8							
	DG48: Design to minimise the impact of noise, air and light pollution	8							

Figure 1D (Part 3 continued): Table setting out the design guide principles and the type of developments to which they are broadly applicable

# 1 Purpose of the Design Guide

## A User-friendly Guide

Design Guide Chapter	Design Principles	National Design Guide Characteristics	DEVELOPMENT TYPES						
			Large, medium and small residential developments (2 to 300+ dwellings)	Brownfield and urban infill	Commercial or employment	Mixed use scheme	Individual houses	Household extensions	Building conversions
<b>9 Household Extensions</b>	DG49: General principles for extensions	1/2/3/8							
	DG50: Front and side extensions	1/2/3/8							
	DG51: Rear extensions	1/2/3/8							
	DG52: Loft conversions and roof extensions	1/2/3/8							
<b>10 Building Conversions</b>	DG53: Principles for conversions of traditional buildings with heritage value	1/2/9/10							
	DG54: Converting office buildings to residential	1/2/9/10							

Figure 1D (Part 4 continued): Table setting out the design guide principles and the type of developments to which they are broadly applicable

# 1 Purpose of the Design Guide

## The Opportunity



### 1.6 Opportunities and Constraints

1.6.1 The District is experiencing pressure for growth with the Mid Sussex District Plan setting a housing provision of 16,390 homes to be built in the period from 2014 to 2031 to meet both the District need and unmet need in Crawley. Employment growth is also anticipated with a business park and Science and Technology Park planned at Burgess Hill.

1.6.2 These new homes and jobs provide opportunities for the District, helping to sustain its towns and villages and improve their economic performance, but also present challenges. The District contains many environmental designations (refer to chapter 2) which influence where development may take place and it is important that change does not erode the essentially rural character of the District, its rich heritage and the distinctive character of its towns and rural settlements.

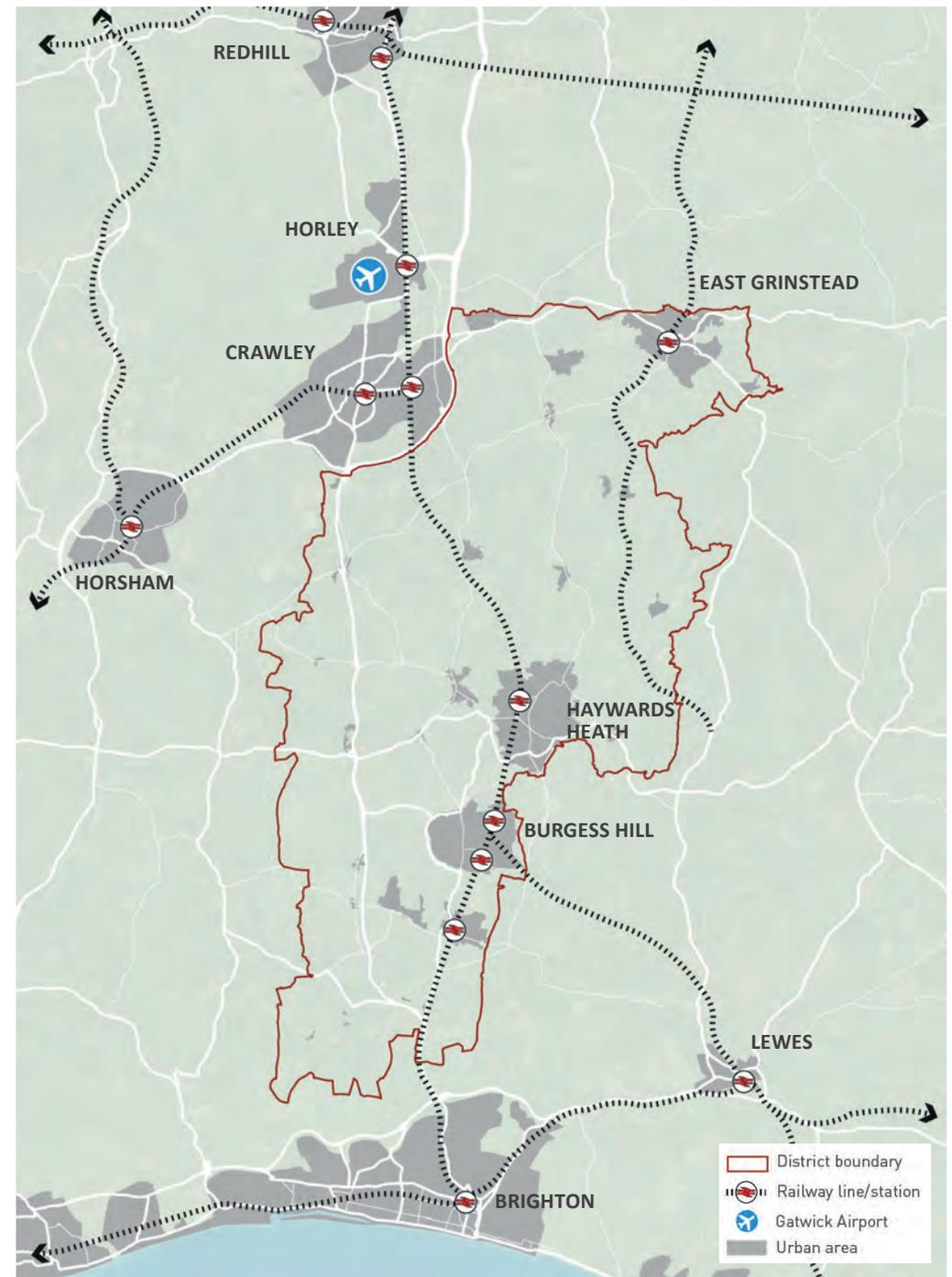

Figure 1E: Mid Sussex Context Plan

# 1 Purpose of the Design Guide

## The Value of Good Design

### 1.7 The Value of Good Design

1.7.1 The importance of design quality is intrinsic to national planning policy with a clear mandate within the National Planning Policy Framework (NPPF) to deliver high quality built-environments.

1.7.2 Design matters because it influences the way we appreciate and experience the villages, towns and homes that we live, work and socialise in. It is through good design that successful places that people want to live and work in are created.

1.7.3 Good design can help transform places and enhance people's lives. The orientation and height of buildings; the materials, enclosure, soft landscaping/trees and amount of sunlight within a public space and the incorporation of inclusive active environments can have a positive impact on physical health as well as upon people's wellbeing and mental health.

1.7.4 Research by the Commission for Architecture and the Built Environment (CABE) and the Royal Institute of British Architects (RIBA) and national guidance, including the Urban Design Compendium, have all demonstrated the link between good design and improved quality of life, equality of opportunity and economic growth:

- A well-designed hospital will help patients get better more quickly;
- A well-designed school will improve the educational achievement of its pupils;
- A well-designed public realm increases retail rents;
- A well-designed department store will have a direct impact on stock turnover; and
- A well-designed neighbourhood will benefit from lower crime and higher house values.

1.7.5 Design affects how people respond to a space and the choices they make when using it. For instance, the amount of sunlight received in a public square will have a significant impact on the quality of the space and upon the economic success and survival of the businesses that surround it.

1.7.6 Good design is about more than just the architecture and in Mid Sussex we are looking to create high quality places that meet the needs of the whole community with streets and spaces that are accessible for everyone, that function well and improve the quality of life.



Recent more innovative design delivered in the District: an exceptional design in the countryside approved under para 55/79 of the NPPF (ABOVE); Woodlands Mead School, Burgess Hill (LEFT)

### High Quality Design and Innovation

1.7.7 The aim of this Guide is to inspire designers to rise to the challenge to deliver high quality, well-designed buildings, streets and spaces that are in keeping with their environment and respond to the challenge to deliver sustainable development.

1.7.8 Designers are encouraged to be inventive and innovative; to prepare proposals that respond to place, that meet the needs of modern lifestyles and that are adaptable in the future. Contemporary solutions of high architectural quality that deliver outstanding places are welcomed and encouraged.

#### Additional useful and interesting resources:

- Paved with gold: The real value of good street design (CABE, 2007)
- By Design, Urban design in the planning system: Towards better practice (DETR and CABE, 2000)
- The value of good design (CABE, 2002)
- The value of urban design (CABE and DETR, 2001)
- Valuing Sustainable Urbanism (Prince's Foundation, Savills and English Partnerships, 2007)
- Public Health England briefing for local authorities - Working together to promote active travel (2016)
- Building the foundations - tackling obesity through planning and development (LGA, 2016)
- Facilities and Planning (Sport England)

# 1 Purpose of the Design Guide

## The Design Process

### 1.8 The Design Process

1.8.1 The delivery of high-quality development is dependent on good design professionals undertaking a robust and iterative design process.

1.8.2 This must ensure that a scheme responds to place and takes account of local issues, opportunities and constraints and the opinions of the public and other stakeholders.

1.8.3 In order to deliver good design there are a number of important steps that must be taken. These steps are indicated in the simple flowchart in Figure 1F.

1.8.4 The level of detail, and engagement required, will be dependent on the scale and complexity of the application.

#### Engaging Professionals

1.8.5 A design guide alone cannot produce good creative solutions; this is the job of a good creative professional. One of the first stages in preparing a design scheme will be to engage skilled design professionals to ensure high-quality solutions through the design process. Mid Sussex District Council strongly encourage planning applicants to employ appropriate design professionals such as architects, landscape architects, arboriculture consultants, heritage consultants and urban designers.

1.8.6 The following organisations can assist with providing contact details for professionals:

- **Landscape Institute**
- **Royal Institute of British Architects**
- **Royal Town Planning Institute**
- **Urban Design Group**

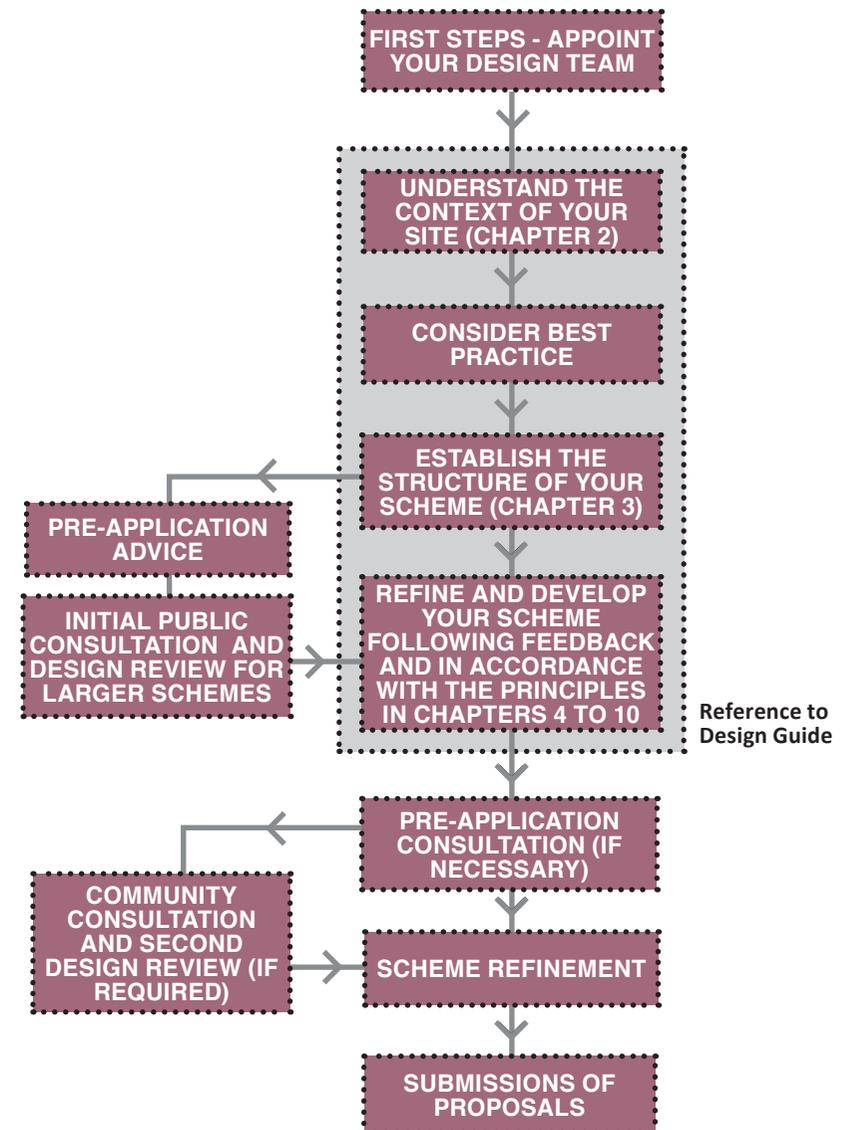

Figure 1F: Flow chart setting out the design process for preparing a design proposal

# 1 Purpose of the Design Guide

## Who to Talk to

### 1.9 Who to Talk to

#### Early Pre-application Consultation

1.9.1 Applicants should hold pre-application discussions at an early stage in the design process. Depending on the scale of development, applicants should consult with relevant statutory and non-statutory authorities (refer to figure 1G) and council officers to:

- Understand policy requirements;
- Discuss emerging ideas and sensitivities;
- Ensure that the design process is heading in the right direction; and
- Discuss the information and level of detail required to accompany a planning application.

#### Community Consultation

1.9.2 Community engagement can be a useful way to discover more about a site and its setting and to gain an understanding of any concerns that the community may have in relation to an application.

1.9.3 Depending on the scale and nature of an application it may be appropriate to carry out consultation with the public and stakeholders. Applicants should refer to the MSDC's Statement of Community Involvement which sets out a Code of Practice for consultation.

1.9.4 Applicants should document the engagement process and demonstrate how community and stakeholder feedback has been taken account of in their proposals.

1.9.5 The Council encourages all applicants and their agents to consult their neighbours before they submit a planning application.

#### Design Review

1.9.6 The NPPF (paragraphs 128 and 129) advocates the use of design review to improve the quality of development. Mid Sussex District Council has established a Design Review Panel (DRP) to provide independent and professional design advice and evaluation of significant schemes, either because of their scale or sensitivity. The DRP's Terms of Reference sets out the criteria for their consideration and other requirements.

1.9.7 Schemes should normally be presented to the Panel early in the design process when the Panel's inputs can be most helpful.

1.9.8 The Council will have regard to the recommendations from the DRP when assessing applications.

#### Relevant Statutory Authorities and organisations

- Natural England: Landscape, Green Infrastructure and Biodiversity;
- High Weald Area of Outstanding Natural Beauty;
- South Downs National Park Planning Authority;
- Historic England: heritage assets;
- West Sussex County Council: access, drainage (as lead local authority (LLFA)), highways, transport, rights of way, archaeology and cultural heritage, education, libraries etc;
- Environment Agency: flooding, rivers and pollution;
- Utility companies;
- Highways England - M23 and A23;
- Police service: police liaison and crime prevention officer;
- Fire service; and
- Town and parish councils.

Figure 1G: Organisations that might be relevant to consult to provide initial advice



# 2 Understanding the Context



# 2 Understanding the Context

## Introduction



### 2.1 Introduction

2.1.1 Mid Sussex is characterised by its historic settlements and beautiful countryside, much of which is protected for their special qualities. A fundamental objective of this Design Guide is to ensure that new development respects, responds to and enhances the unique characteristics of the District. An understanding of context is therefore an essential starting point.

2.1.2 This chapter provides an overview of Mid-Sussex, outlining what makes it distinctive and special. It identifies the important characteristics that an applicant will be expected to consider to:

- Understand the context and character of their site; and
- Establish the constraints and opportunities that will guide their proposals.

2.1.3 Applicants will be required to demonstrate a clear link between their appraisal of the context, any applicable planning designations, the character of their site, physical constraints and opportunities and their development proposals. This link or rationale will need to be articulated through the Design and Access Statement that will support their planning application.

2.1.4 A checklist is provided at the end of the section providing prompts to applicants on the issues that may be relevant and require consideration in understanding their site and the context within which it is located.

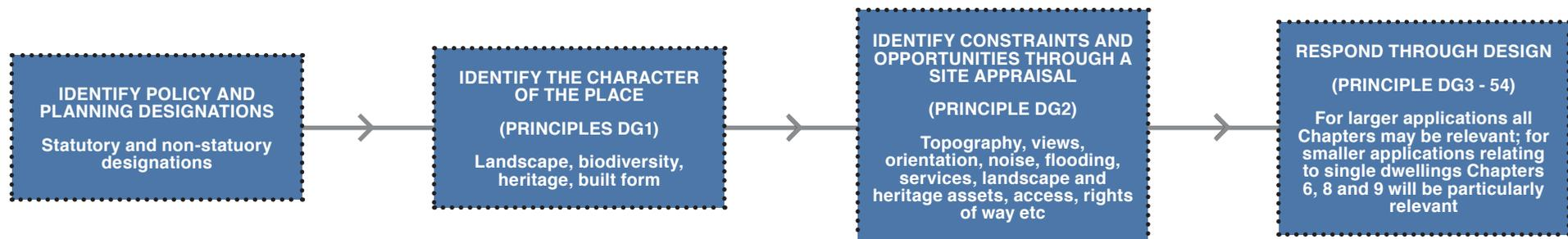

Figure 2A: Flowchart indicating the process applicants should follow to 'Understand the context' of their site

# 2 Understanding the Context

## Overview of the District

### 2.2 Overview of the District

2.2.1 The Mid Sussex District covers an area of approximately 33,400 hectares and stretches from its boundary with Surrey in the north to the boundaries of Brighton and Hove in the south. The District has a distinctive settlement pattern, containing three main towns, Burgess Hill, Haywards Heath and East Grinstead together with a large number and wide variety of villages.

2.2.2 The London to Brighton main line railway and A23 trunk road run north-south through the District providing good connections particularly for Haywards Heath and Burgess Hill.

2.2.3 The District's environment is protected by international, national and local designations which seek to preserve the area's natural and built environment for future generations.

2.2.4 49% of the District is within the High Weald Area of Outstanding Natural Beauty (AONB) and Mid Sussex is the tenth most wooded District in the South East with two-thirds of this woodland classified as 'ancient'. The High Weald AONB Partnership has prepared its own design guide that will need to be considered for sites within the AONB.

2.2.5 The District also has many sites valued for their biodiversity including Sites of Special Scientific Interest, Sites of Nature Conservation Importance, Local Nature Reserves and Biodiversity Opportunity Areas. The District also has over 1,000 Listed Buildings, 25 Ancient Monuments, over 500 Sites of Archaeological Interest, 36 Conservation Areas and 9 Registered Parks and Gardens.

2.2.6 Approximately 10% of Mid Sussex District lies within the South Downs National Park. The National Park Authority is the local planning authority for this area and has adopted its own Local Plan for the whole of the National Park which will apply to the area within Mid Sussex that falls within the National Park.

2.2.7 Applicants will need to carry out their own desktop analysis to understand whether their site is covered by any designations. Applicants should check the Policies Maps on the Council's website for further details.

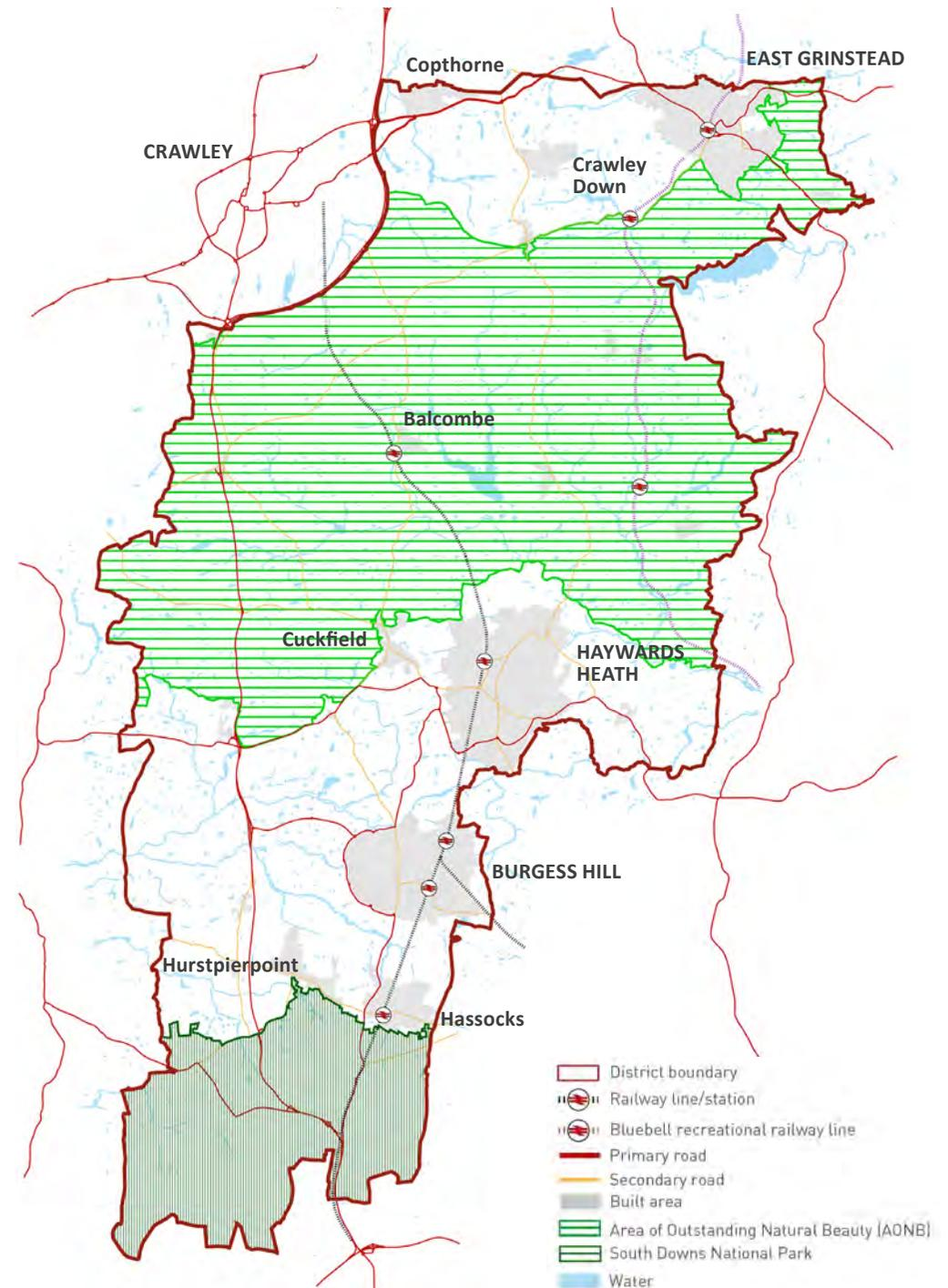

Figure 2B: Mid Sussex Overview Plan

## 2 Understanding the Context Overview of the District

### REFERENCES

District Plan Policy DP16: High Weald Area of Outstanding Natural Beauty

District Plan Policy DP18: Setting of the South Downs National Park

District Plan Policy DP37: Trees woodland and hedgerows

2.2.8 Designations and features that help to characterise Mid Sussex include:



### High Weald AONB

**Area:** 16,353Ha (49% of the District),

**Character:** a medieval landscape of rolling hills, woodland, ancient route ways and farmsteads. Offers long views from the ridges with water courses the valleys.

**Importance:** Any development within the AONB must conserve and enhance its distinctive features. Land outside of the AONB contributes to its setting and should not adversely affect views in and out of the AONB.



### South Downs National Park

**Area:** 3,684Ha (11% of the District)

**Character:** open elevated landscape that offers spectacular views across the Weald.

**Importance:** Land surrounding the South Downs National Park makes a contribution to its setting and development must not detract from, or cause detriment to, the National Parks visual and special qualities including views and outlook, tranquillity and dark skies.



### Woodland

**Area:** 9,158Ha (27.4% of the District)

**Character:** Mid Sussex's woodland is an integral part of its character both within the wider landscape and where it extends into, or close to, settlements.

**Importance:** Woodland enhances the setting of settlements and the wider landscape helping to conceal development, contributing to the landscape mosaic, conferring a sense of intimacy, seclusion and tranquillity and supporting wildlife.

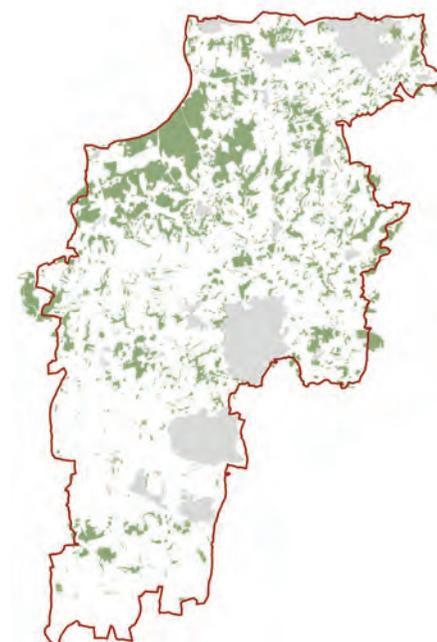

### Ancient Woodland

**Area:** 5,741Ha (17.2% of the District)

**Character:** As 'Woodland'.

**Importance:** This land has been woodland since 1600 or before. It is therefore particularly important in the District and requires a greater level of protection and larger buffer zones.

## 2 Understanding the Context Overview of the District

### REFERENCES

District Plan Policy DP34: Listed buildings and other heritage assets

District Plan Policy DP35: Conservation Areas

District Plan Policy DP36: Historic Parks and Gardens

District Plan Policy DP38: Biodiversity

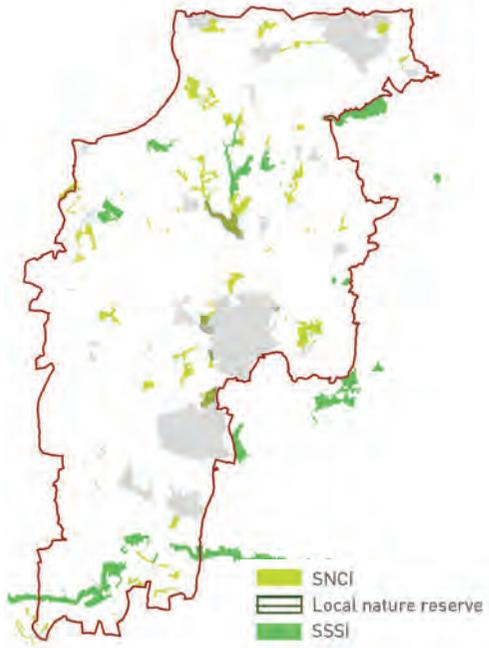

### Nature Conservation

**Area:** 1,938Ha (5.8% of the District)

**Character:** Varies .

**Importance:** These designations protect environments that are important for nature conservation.



### Water and Rivers

**Area:** 476Ha (1.4% of the District)

**Character:** The extensive network of watercourses running from the District's higher ground to its valleys are an important feature of the landscape within the District.

**Importance:** The District's watercourses enhance character and biodiversity and should be retained and protected within development.

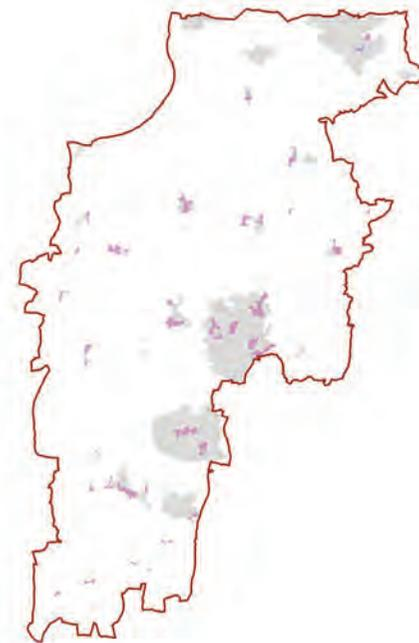

### Conservation Areas / Heritage

**Area:** 438Ha (1.3% of the District)

**Character:** Characteristics of each of the 36 Conservation Areas is described on the Council's website.

**Importance:** Designated for their special architectural or historic interest. The District includes over 1,000 Listed Buildings, 25 Scheduled Ancient Monuments and over 500 Sites of Archaeological Interest (West Sussex Historic Environment Record).

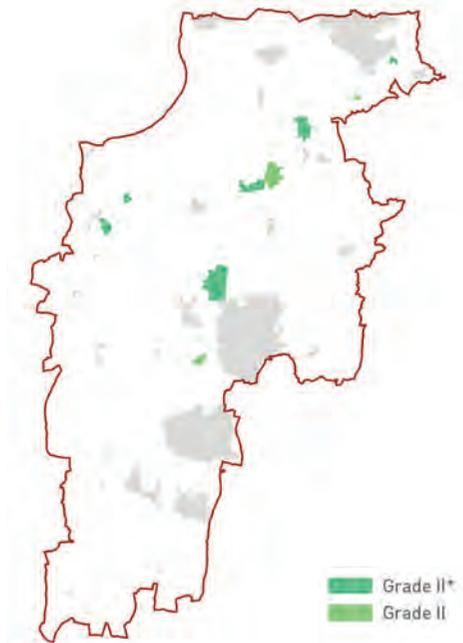

### Historic Parks and Gardens

**Area:** 435Ha (1.3% of the District)

**Character:** Designed landscapes often associated with country houses (9 across the District including Standen House, Wakehurst and Nymans).

**Importance:** Designated for their special local historic interest.

## 2 Understanding the Context Character Study



Hurstpierpoint College viewed across fields

### 2.3 Character Study

#### Principle DG1: Character Study

Applicants should clearly identify whether their site lies within or in the setting of any statutory or non-statutory designation. Any development proposals within or in the setting of one or more of these designations will be required to demonstrate how the proposals respond to national and local policies relevant to the designation.

After identifying the relevant Planning designations, applicants should prepare a Character Study that identifies the context within which the application site is set, considering both the characteristics of the landscape and the settlement within which it is located or relates. This Study will help to guide and inform the proposals that are prepared later in the design process including the opportunities to contribute positively to the sustainability agenda.

#### REFERENCES

District Plan Policy DP26: Character and Design

2.3.1 Mid Sussex District Council will normally require a Character Study to be prepared to support a development proposal, irrespective of scale for any development proposal requiring a Design and Access Statement. The objective of the Character Study is to identify, analyse and describe in a systematic and objective way, those elements, or combination of elements, that have a positive role in guiding development and by contributing to reinforce local identity and creating a defined sense of place. Elements may be drawn from the immediate surroundings or (where relevant) from adjacent settlements or landscapes within Mid Sussex.

2.3.2 The level of detail in the study should be related to the scale of the development proposals. For example:

- A proposal for an urban extension should be supported by a comprehensive study to consider the extension in the context of the existing settlement, its location in the wider landscape and its movement and green space network, carefully considering how the development would integrate with and enhance the settlement;
- An application for infill development or single dwelling may just consider the character of the street and the neighbouring properties to inform how the development can successfully complement the streetscene; and
- For sites located in areas where it may not be desirable to replicate or respond to the immediate character, applicants should consider adjacent areas or settlements and draw from those elements which help make Mid Sussex a distinctive place.

## 2 Understanding the Context

### Landscape Character

#### 2.4 Landscape Character

2.4.1 As part of the Character Study applicants should identify the landscape character within which their site is located, the specific landscape characteristics of the area and consider how this might influence and guide their development proposals.

2.4.2 The landscape of Mid Sussex is essentially rural in character, dominated by fields and interspersed with small woods and settlements of farms and hamlets. This is highly valued by the Council and local residents, and the network of paths and roads provides access and walking opportunities that enhance the health and wellbeing of residents and visitors.

2.4.3 The character of the landscape varies across the District both in terms of landform, tree cover and openness and this has an influence upon where settlements are located and the opportunity to accommodate development in the future.

2.4.4 The District crosses the main geological divisions of the Weald and the South Downs and contains three national Character Areas: High Weald, Low Weald and South Downs.

2.4.5 The structure and relief of the landscape is fundamentally influenced by the underlying rocks. Geology and the process of weathering, erosion and deposition influence the shape and form of the landscape and its drainage and soils. In turn, these influence patterns of vegetation and land use.

2.4.6 Woodland is a major component of the landscape of the District, particularly in the High Weald. Over 30% of the High Weald AONB area is wooded, with 90% of ancient woodlands having survived since 1600.

2.4.7 Further information on landscape character can be found in the Mid Sussex Landscape Character Assessment 2005.

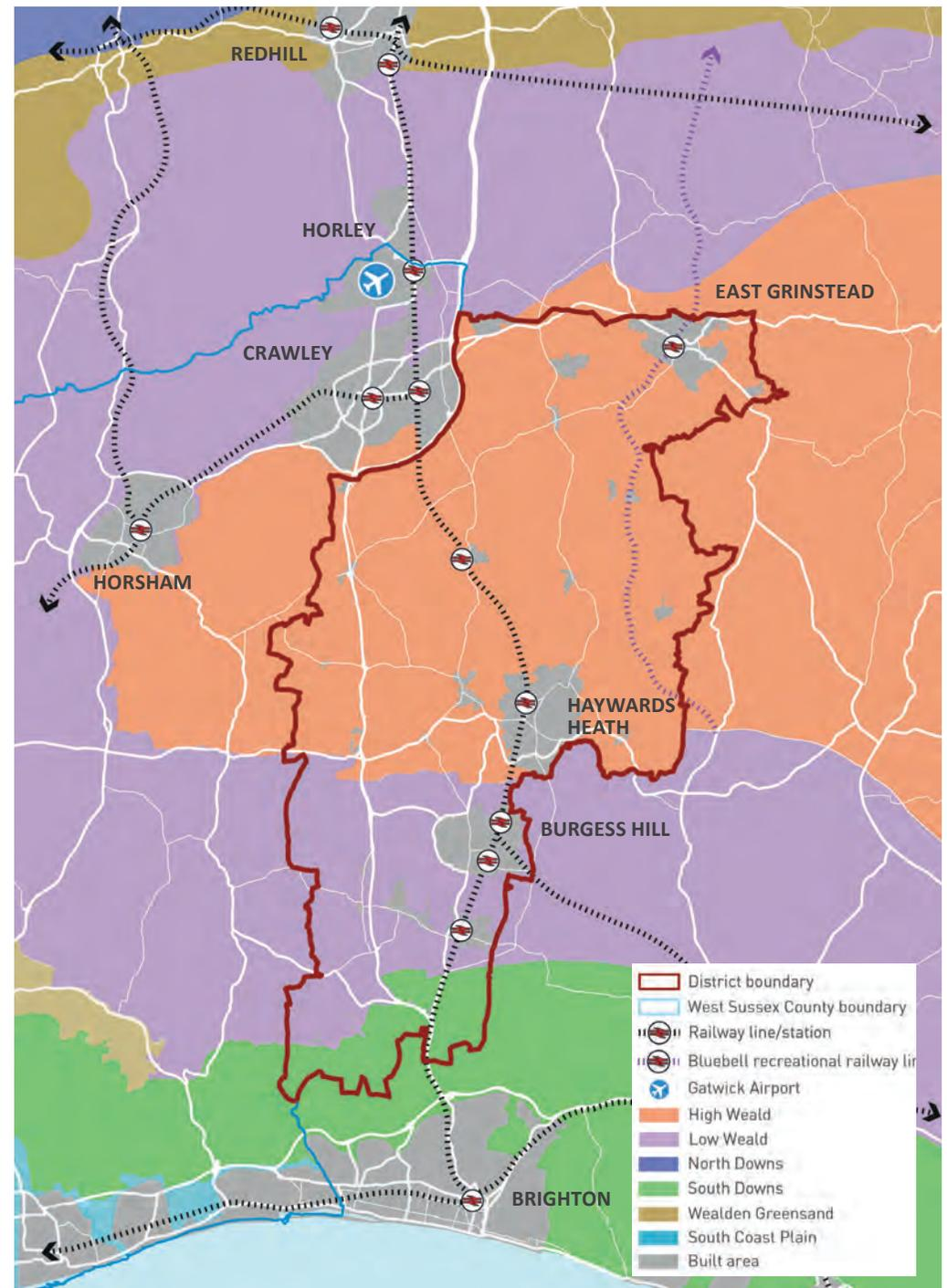

Figure 2C: National landscape character areas

## 2 Understanding the Context Landscape Character

REFERENCES  
The Landscape Character Assessment for Mid Sussex (2005)

### Landscape Character Areas and their Characteristics

The landscape character assessment sub-divides the District into ten character areas.

Area	Landform and Landscape	Settlement Pattern	Local Materials
 <b>High Weald</b>	Hilly landscape of ridges and secluded valleys with significant woodland cover and a dense network of hedgerows and copses, creates a sense of enclosure.	Historic settlements on high ridges, hilltops and high ground and connected by twisting lanes. The principal settlement is East Grinstead and some expanded and smaller villages.	Diverse materials including timber framing, Wealden stone and varieties of local brick and tile hanging.
 <b>High Weald Plateau</b>	A plateau landscape with significant woodland cover and a dense network of hedgerows and copses, creates a sense of enclosure.	Main settlements at Copthorne and Crawley Down have expanded through 20th century. Roads busy with ribbon development in places.	Diverse materials including timber framing and varieties of local brick and tile hanging.
 <b>Worth Forest</b>	Densely wooded, plateau landscape with long views over the Low Weald to the South Downs.	Sparse, dispersed settlement pattern of farmsteads.	Diverse materials including timber-framing, Wealden stone and varieties of local brick and tile-hanging.
 <b>Ouse Valley</b>	Rural valley landscape with the watercourse broadening from a stream in the west to a river meandering through water meadows in the east.	No settlements in the valley other than dispersed farmsteads although Haywards Heath, Lindfield and Cuckfield lie on the valley edges.	Diverse materials including timber-framing, Horsham Stone roofing, Wealden stone and varieties of local brick and tile-hanging.
 <b>High Weald Fringes</b>	Densely-wooded southern flanks of the High Weald Forest Ridge.	Dispersed historic settlement pattern, with Cuckfield, Haywards Heath and Lindfield and a few villages and hamlets to the east.	Diverse materials including timber-framing, Horsham Stone roofing, Wealden stone and varieties of local brick and tile-hanging.

Figure 2D: District landscape character areas

## 2 Understanding the Context

### Landscape Character

Area	Landform and Landscape	Settlement Pattern	Local Materials
	<b>Hickstead Low Weald</b> Lowland mixed arable and pastoral landscape with a strong hedgerow pattern.	Mix of farmsteads and hamlets often in ridgeline locations, and with Burgess Hill to the east.	Diverse materials including timber-framing, weatherboarding, Horsham Stone roofing and varieties of local brick and tile-hanging.
	<b>Upper Adur Valley</b> A small part of the extensive upper catchment of the River Adur.	Agricultural landscape with farmsteads and hamlets.	Diverse materials including flint, timber-frame and varieties of local brick and tile-hanging.
	<b>Hurstpierpoint Scarp Footslopes</b> Undulating arable and pastoral landscape with areas of ancient woodland on the lower lying areas.	Expanded ridgeline villages with suburban development at Hurstpierpoint and Hassocks. Also smaller villages and dispersed farmsteads.	Diverse materials including flint, timber-framing, Horsham Stone roofing and varieties of local brick and tile-hanging. Also painted render.
	<b>Fulking to Clayton Scarp</b> Distinctive steep, abrupt chalk escarpment with precipitous north-facing slopes.	Few buildings on the step slopes.	
	<b>Devil's Dyke and Clayton Downs</b> Elevated, open rolling landform of hills, dry valleys and a steep escarpment on chalk bedrock. Panoramic views.	Isolated farms and farm buildings on the high downland and sparse settlement elsewhere, clustered in the valleys, in hamlets and farmsteads.	Traditional rural buildings built of local flint and brick with weatherboarded barns.

Figure 2D (continued): District landscape character areas

NOTE: Fulking to Clayton Scarp and Devil's Dyke and Clayton Down landscape character areas and part of the Hurstpierpoint Scarp Footslopes landscape character area are within the South Downs National Park.

## 2 Understanding the Context Settlement Character



### 2.5 Settlement Character

2.5.1 Mid Sussex has a distinctive settlement pattern of small to medium-sized towns, villages and hamlets.

2.5.2 A settlement hierarchy is identified in Policy DP6 of the District Plan with five categories of settlement characteristics. This ranges from the larger settlements Haywards Heath, Burgess Hill and East Grinstead (Category 1) to the small settlements or hamlets (Category 5).

2.5.3 The three towns are the focus for shopping, employment and community and cultural uses across the District. Along with strategic allocations they present the greatest opportunity for change and intensification to meet the District's housing and employment needs during the Plan period.

2.5.4 Larger villages in the District (Category 2 and 3) act as local centres for their immediate catchment and typically have a historic village centre structured around a church and high street. These villages have continued to grow with successive suburban developments extending the villages into the surrounding countryside.

2.5.5 Many of the District's smaller settlements (Category 4 and 5) have seen only modest growth and remain as strings of homes extending along a route or more often clustered around the meeting point of several routes. These have a close relationship with the surrounding countryside and this makes them particularly sensitive to new development.

REFERENCES  
District Plan Policy DP6:  
Settlement hierarchy

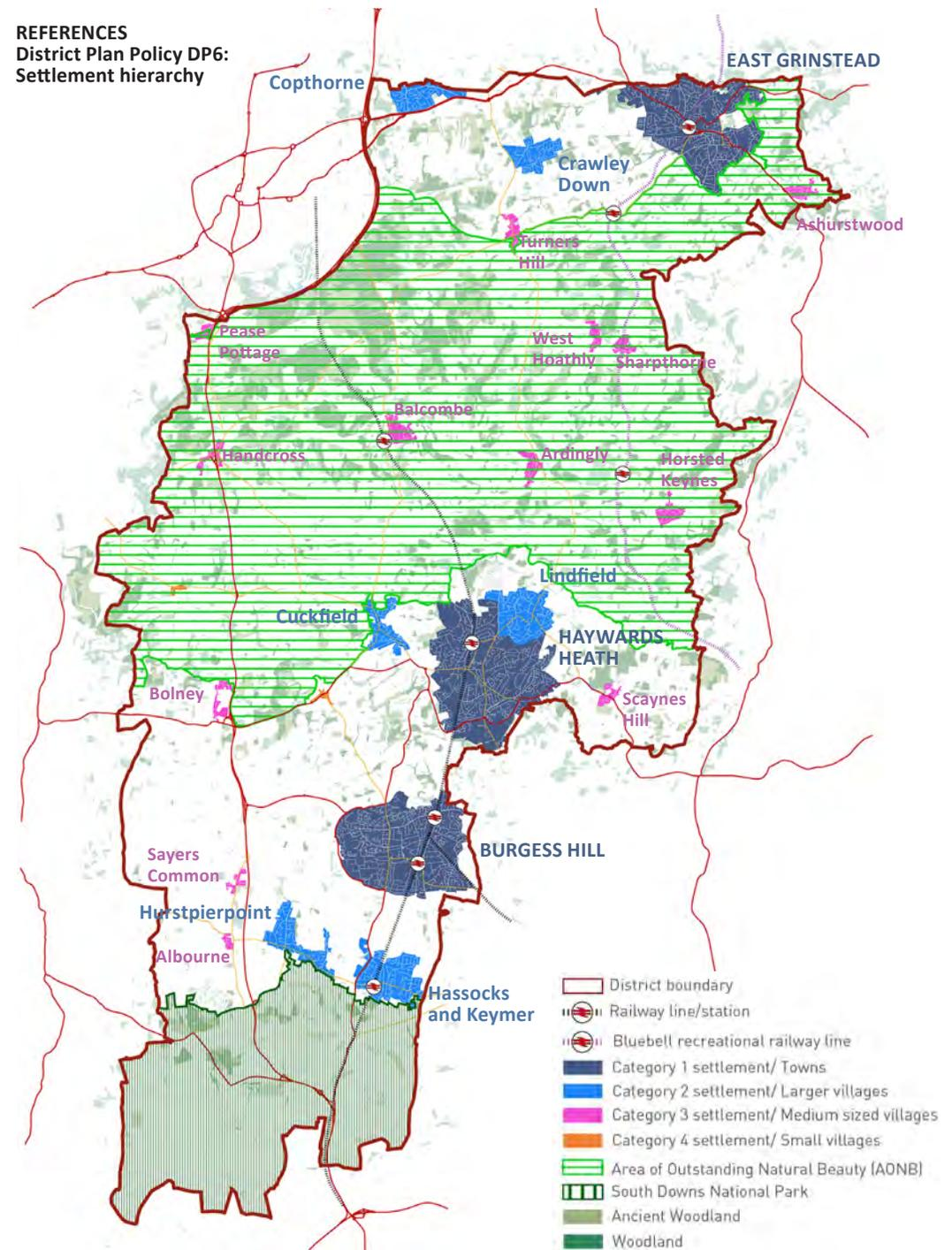

## 2 Understanding the Context

### Settlement Character

#### Settlement Contexts

2.5.6 The pattern of settlements gives rise to broad character types across the District (further information on settlement context can be found in Mid Sussex District Council's Extensive Urban Surveys, Conservation Area Appraisals, Neighbourhood Plans and Village Design Statements):

#### Fine Grain Urban Centres

2.5.7 The historic centre (pre-20th Century) of the District's towns and villages typically benefit from a development pattern that is fine grain where they have avoided significant post-war change. The fine grain pattern is characterised by tightly enclosed streets, squares and alleys defined by small scale street frontage buildings that have predominantly narrow frontages generating a vertical rhythm. These areas are often rich in character as they normally include: (a) historic buildings of heritage value and a high level of archaeological interest; (b) mixed use buildings around well enclosed spaces that help provide a sense of activity.



2.5.8 In some centres the fine grain development is mixed and includes Victorian, 1930s and later development. In these areas the quality of the built fabric varies and there may be scope for some modest change and intensification depending upon the context and character of the area.

#### Coarse Grain Urban Centres

2.5.9 The District's town centres are also characterised by coarser grain areas with a less consistent built form that reflects greater change. These areas include larger floorplate single-use buildings of a greater scale and massing and a mix of uses including shopping centres, offices, food stores and apartment buildings.



2.5.10 The quality of the environment is sometimes degraded by larger buildings that do not successfully respond to their urban context and fail to adequately define the streets and spaces. This can be because of the shape, size and design of the buildings that do not comfortably fit their urban context and because vehicle access requirements including extensive surface car parks has created weaker street enclosure, a more hard-edged environment and negative spaces.

2.5.11 The coarse grain areas offer development opportunities for significant improvement by both repairing and enhancing the street environment while also helping to regenerate town centres through intensification, mixed uses and increasing the residential population around existing and new facilities.



#### Victorian / Edwardian Urban Streets

2.5.12 The edge of town centres features Victorian and Edwardian residential streets. These typically comprise two storey brick-built houses set close to the footway behind a small garden / privacy strip which is often defined by a low brick wall. Car parking is generally on-street. These areas are urban in character and laid out as part of a gridded structure of connected streets with medium densities of 30 to 50 dwellings per hectare (dph).

2.5.13 Some streets have a lower density and are characterised by detached villas with larger and more verdant front thresholds which often accommodate off-street parking.

## 2 Understanding the Context

### Settlement Character



#### Suburban Context

2.5.14 Post-war development is mostly characterised by suburban housing. Many of the established suburban areas benefit from mature and new trees that help to soften the impact of developments. These are often native species either part of former hedgerows or copses, or sometimes exotic conifers planted in Victorian times and now grown to a significant size and often visible from a distance. In other areas the public realm can be unattractively dominated by estate roads and car parking. The sense of place can also be undermined by weak street enclosure resulting from wide streets (including deep front thresholds) and gaps in building frontages. Suburban residential densities are normally between 20 and 35 dph.

#### Traditional Rural Village Context

2.5.15 The relationship of streets and dwellings to the surrounding landscape, including the views out to the open countryside, is important within many villages, and this makes them particularly sensitive to new development. Village centres are often characterised by tightly clustered buildings that define space around intersecting routes, main streets and important spaces (such as village greens).

#### Rural Context

2.5.16 The countryside features isolated dwellings, country estates and small groups of dwellings such as hamlets and farm buildings. In these locations the surrounding landscape is the dominant feature.

#### Industrial Estates

2.5.17 Mid Sussex's towns feature industrial estates that present a different urban structure that is characterised by large floorplate buildings and sheds set within service yards accessed by estate roads. These areas provide an important part of the local economy but often present an unattractive and illegible pedestrian environment. These estates typically present opportunities for intensification and improvement particularly to the street environment.

## 2 Understanding the Context Town Centres

### 2.6 Mid Sussex's Town Centres

2.6.1 The Mid Sussex District Plan 2014-2031 supports the regeneration and renewal and environmental enhancement of Mid Sussex's town centres including mixed use and tourism related development, provided it is appropriate in scale and function to its location including the character and amenities of the surrounding area and has regard to the relevant Town Centre Masterplans and Neighbourhood Plans. This section provides an overview of the three towns that sets the context for their potential future growth which is defined in chapter 5.

#### Haywards Heath

2.6.2 Haywards Heath is a railway town established in the 19th century following the opening of the London-Brighton line that encouraged commuting and an increasing diversity of trades, businesses and retail outlets.

2.6.3 The name Haywards Heath describes the heath on which the core of the town was built following the opening of the railway in the 1840's. The railway was intended to serve the existing nearby villages of Cuckfield and Lindfield and precipitated rapid growth through the 19th century. This was underpinned by the establishment of a corn market and later a fortnightly cattle market that served the wider area. It was followed by an increasing diversity of trades, businesses and retail outlets to the town.

2.6.4 The town centre is dispersed, extending in a linear fashion from the station along Perrymount Road, The Broadway, South Road and Sussex Road and a commercial district has established around the station notably on Perrymount Road. The cafes and bars in the Broadway, with their outdoor seating, provides Haywards Heath with a congregating area.

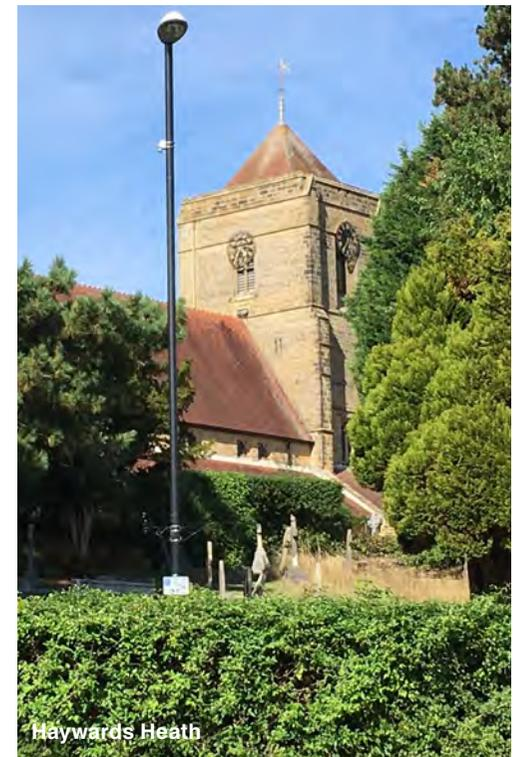

## 2 Understanding the Context Haywards Heath



### Neighbourhood Plan Vision

2.6.5 The vision for Haywards Heath set out in the **Neighbourhood Plan** is to achieve:

- A healthy, family focused and safe town;
- A strong community spirit embracing both young and older people;
- A vibrant economy;
- Excellent public services; and
- High quality public spaces with the countryside on its doorstep.

2.6.6 Within the town centre the Neighbourhood Plan encourages a diverse range of uses including new office, leisure, community, hotel, retail and residential uses which can be shown to support the core retail offer and generate vitality and add viability to the town centre whilst avoiding harm to existing businesses and residential properties.

### Haywards Heath Town Centre Masterplan Supplementary Planning Document (SPD)

2.6.7 The Council has prepared a Town Centre Master plan for Haywards Heath which sets out a vision, objectives and guiding principles for the future development of the town centre. These include seeking to strengthen Haywards Heath's position as the 'Heart of Mid Sussex' by ensuring investment and development is focused on nurturing community and attracting people to visit, work and live in the town centre. Development proposals within the town centre boundary as defined by the Haywards Heath Masterplan will need to be in accordance with its recommended proposals.

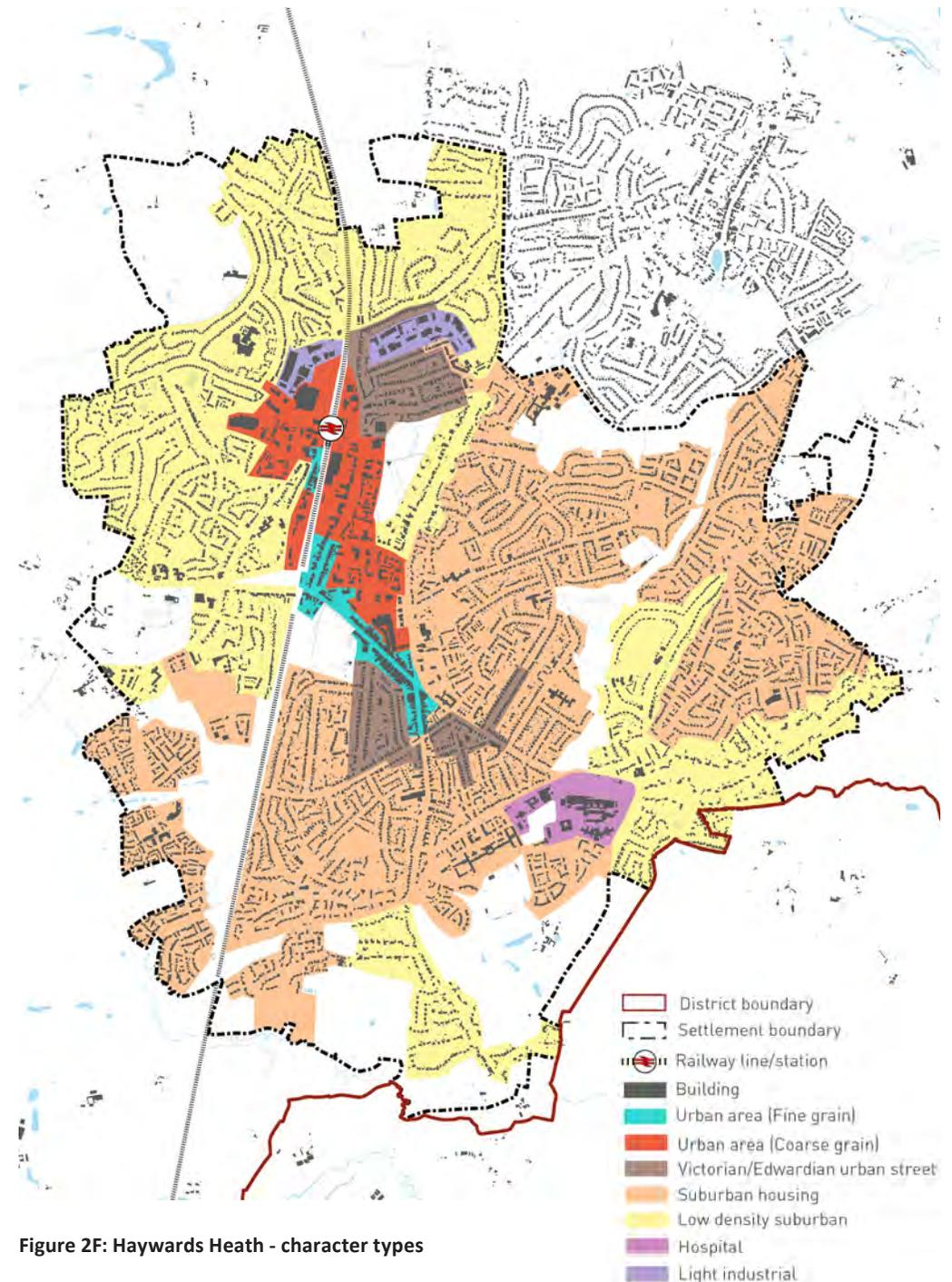

## 2 Understanding the Context Haywards Heath



### Development Constraints

2.6.8 There are valued townscapes in Haywards Heath where there is less scope for new development. Within the town centre, this includes the areas defined as fine grained (refer to paragraphs 2.5.7 and 2.5.8 and Figure 2F). The following features of the town centre are especially sensitive to development:

- The Conservation Areas including the areas surrounding the key open spaces of Muster Green and the Heath.
- The Listed Buildings include the Priory and St Wilfrid's Church which are important local landmarks. The latter benefits from its juxtaposition with the adjacent Victoria Park that also reveals long views of the South Downs from South Road.

- Prominent and sloping sites: Haywards Heath is set within rolling hills that requires the scale and massing of development in the town to respond carefully to its topography with consideration given to the potential visual impact especially on higher land (from both short and long-distance views).

### Development Opportunities

2.6.9 Most opportunities lie in the coarse grain areas (as defined in paragraphs 2.5.9 to 2.5.11) where the quality of the existing built fabric is varied this includes the area around the station, Perrymount Road and the Orchards shopping centre (refer to chapter 5 - Site Optimisation).

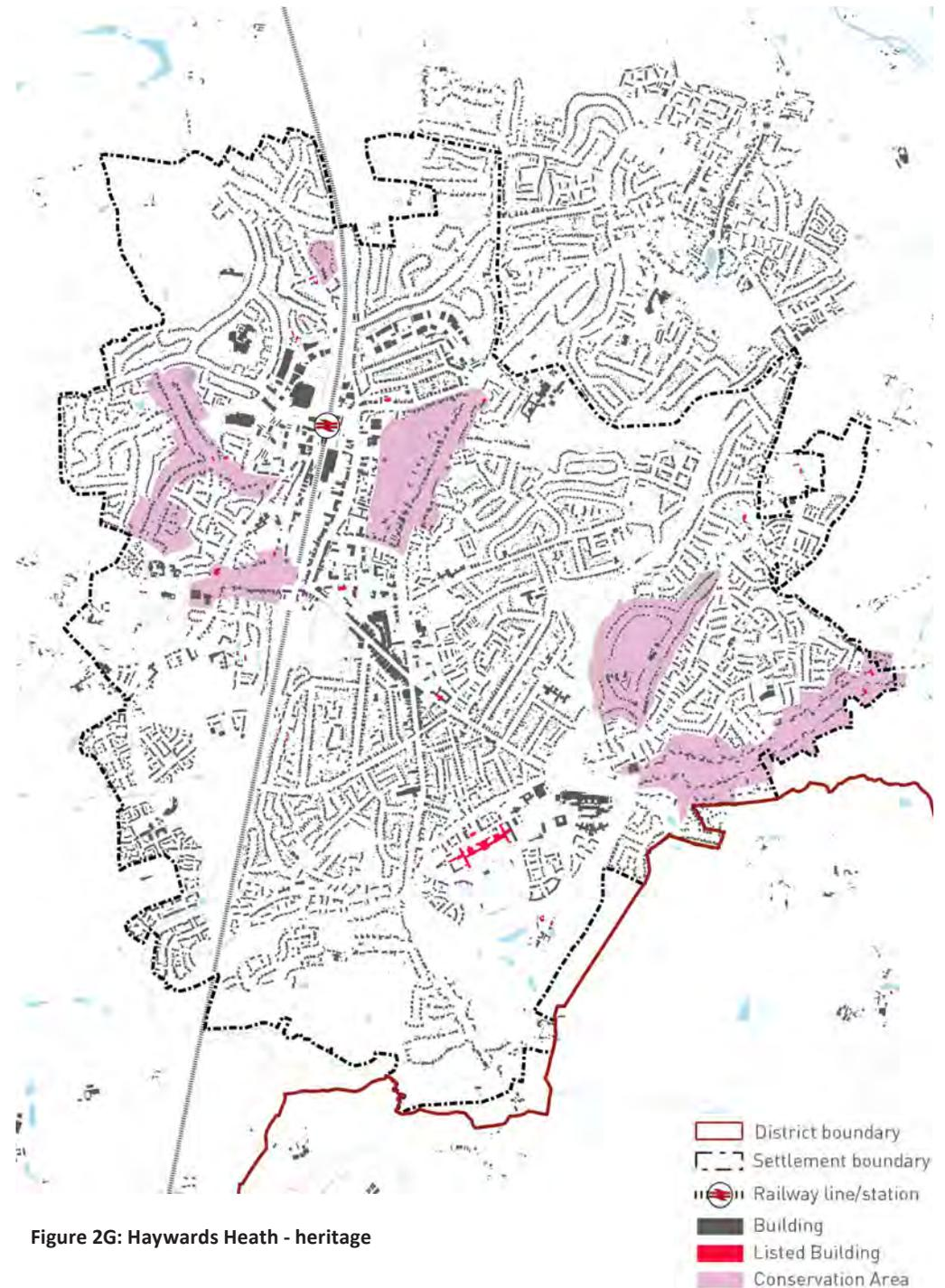

Figure 2G: Haywards Heath - heritage

## 2 Understanding the Context Burgess Hill



### Burgess Hill

2.6.10 The railway facilitated the growth of Burgess Hill with the local brick and tile works supplying the materials for the new buildings. Between 1850 and 1880 it grew from a rural settlement to a town of 4,500 residents.

2.6.11 The name Burgess Hill has described the hill just east of the railway station since at least the 15th century. Until the arrival of the London to Brighton railway in the 1840s the adjacent St John's Common (to the north-west) was a more conspicuous settlement, being the location of both brickworks and substantial newly-built villas.

2.6.12 Through the 20th century the traditional brick, tile and pottery industry in Burgess Hill was replaced by the banking and finance sectors, and the town now has a concentration of high technology industry and commerce, principally in the Sheddingdean and Victoria business parks to the north and west of the town centre.

2.6.13 Burgess Hill's principal shopping area is concentrated on Church Road with some commercial businesses on London Road.

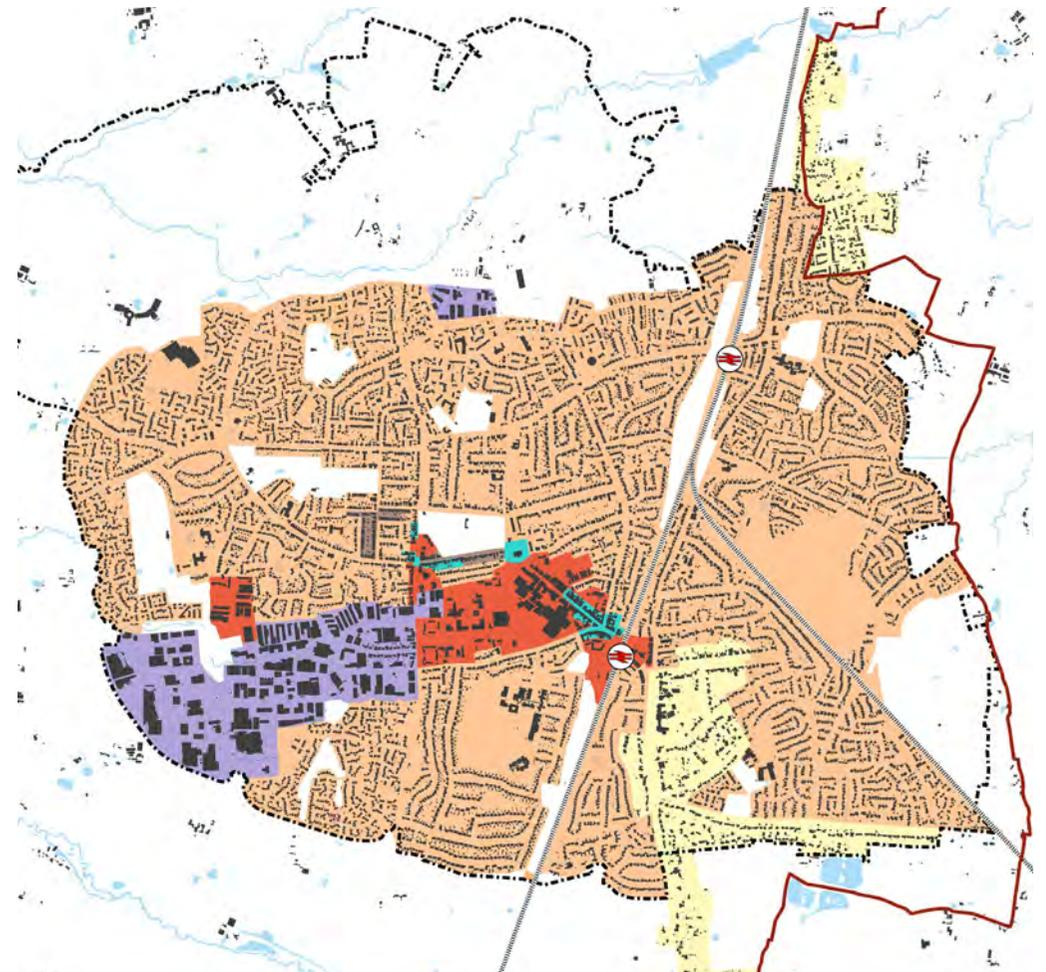

Figure 2H: Burgess Hill - character types

## 2 Understanding the Context Burgess Hill

### Neighbourhood Plan Vision

2.6.14 The **Burgess Hill Neighbourhood Plan** sets out a vision for the town that:

*'Seeks to provide a sustainable 21st century town, focused around a vibrant town centre; where the existing and future population can enjoy a range of community facilities and high-quality green space for play and recreation.'*

2.6.15 The core objectives include:

- Promote the vitality and vibrancy of Burgess Hill town centre and enhance the accessibility and public realm within the town centre; and
- Promote sustainable and well-designed development in the right location that accounts for the character and amenity of the local area.

2.6.16 The Neighbourhood Plan establishes five areas within the town centre where new development and investment is to be focused each with its own identity and range of projects.

### Development Constraints

2.6.17 There are valued townscapes in Burgess Hill where there is less scope for new development. Within the town centre, this includes the areas defined as fine grained (refer to paragraphs 2.5.7 and 2.5.8 and Figure 2H). St John's Conservation Area including the park and the listed St John's Church, an important local landmark visible along the length of Church Road / Church Walk, are especially sensitive to development.

### Development Opportunities

2.6.18 Most development opportunities lie in the coarse grain areas (as defined in paragraphs 2.5.9 to 2.5.11) that includes much of the town centre that suffers from a fragmented layout and buildings of varying quality. It would benefit from a new more urban street-based character with a less confusing pedestrian environment (refer to chapter 5 - Site Optimisation).

2.6.19 The ambitious Strategic Growth Programme for Burgess Hill will help the regeneration of the town. As well as the proposed redevelopment of the Martlets shopping centre this involves 5,000 new homes and 15,000 jobs (including construction jobs) together with supporting infrastructure

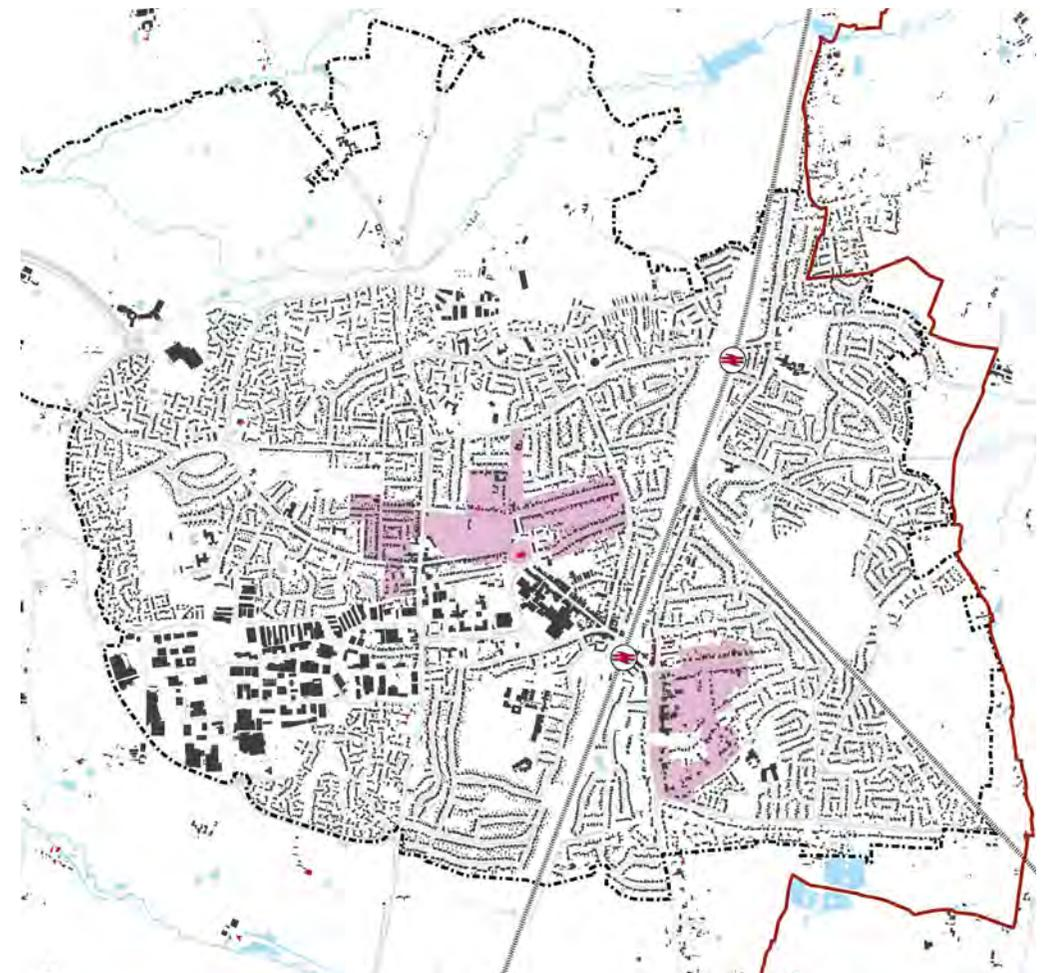

Figure 2I: Burgess Hill - heritage



including schools, health and leisure facilities. Most of this (3,500 homes, 3 schools and 25 hectares of employment land / business park) is proposed as part of the Northern Arc development on the northern edge of the town.

## 2 Understanding the Context East Grinstead



### East Grinstead

2.6.20 East Grinstead is a hill town, situated on the northern edge of the High Weald on a ridge overlooking the valleys of the eastwards flowing rivers – the Medway (to the south) and the Eden (to the north). The historic core of the town sits on the high ground with the 19th and, especially, 20th century suburbs spreading out over the slopes. The surrounding street layout of the town centre has seen only minor changes since the 19th century.

2.6.21 The town dates from Saxon times and is mentioned in the Domesday Book (1086). In the 13th century it was awarded a charter allowing it to hold weekly markets and an annual fair that attracted people from a wide area.

2.6.22 Through the 16th to 18th centuries the town's importance in the county was evident through it being the location for local courts (assizes). At the same time leather working and iron production were important to the local economy.

2.6.23 Located on the main London to Lewes Road, the town provided an overnight stay for travellers. Later in the mid-18th century it became a stagecoach town for people travelling to Brighton.

2.6.24 The creation of a more direct route to Brighton in the 18th century, bypassing the town, and the opening of the London to Brighton mainline railway in the 1840s slowed the town's expansion but the arrival of the railway in the 1850s nevertheless led to continued growth through the 20th century.

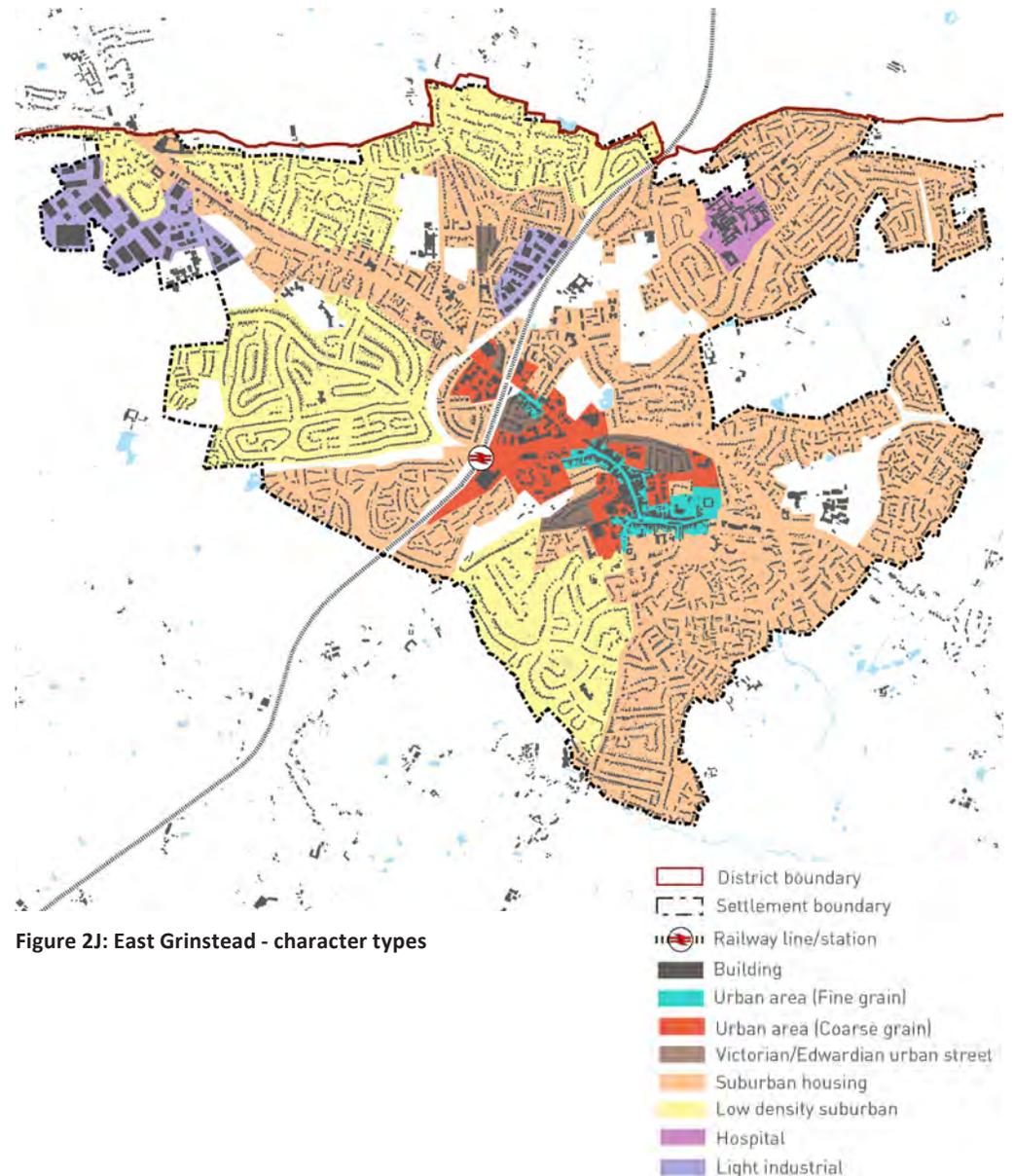

## 2 Understanding the Context East Grinstead

### Neighbourhood Plan Vision

2.6.25 The vision for the town set out in the **East Grinstead Neighbourhood Plan** is:

*‘To provide for a positive future for East Grinstead that is socially inclusive for all, vibrant, economically robust and will allow residents to live with a high degree of self-sufficiency in a town with a first rate natural, built and historic environment’.*

2.6.26 Its core objectives include to:

- Make prudent use of natural resources by promoting development on previously developed sites within the built-up area boundary; and
- Promote development that will provide sustainable economic growth, including business and tourism related development and maintain a prosperous town centre.

2.6.27 The Neighbourhood Plan seeks the redevelopment of Railway Approach though a mixed-use scheme and the comprehensive redevelopment of Queens Walk for a mix of uses comprising retail, restaurant/café uses at ground floor, office and/or residential uses at upper floor level.

### Development Constraints

2.6.28 There are valued townscapes in East Grinstead where there is less scope for new development. Within the town centre, this includes the areas defined as fine grained (refer to paragraphs 2.5.7 and 2.5.8 and Figure 2J). The following features of the town centre are especially sensitive to development:

- The Conservation Area covering the eastern portion of the town centre. This includes the buildings and burgage plots along the High Street which are amongst the best survivals of late medieval and early post-medieval Sussex.
- There are numerous Listed Buildings, or groups of buildings in the town centre especially the High Street where they date from the 15th to 17th centuries.
- East Grinstead is set at the top of a ridgeline; both St Swithun’s Church and the nearby Water Tower are important landmarks. Development needs to respond carefully to the varied topography and consider the relationship to and from the wider countryside.

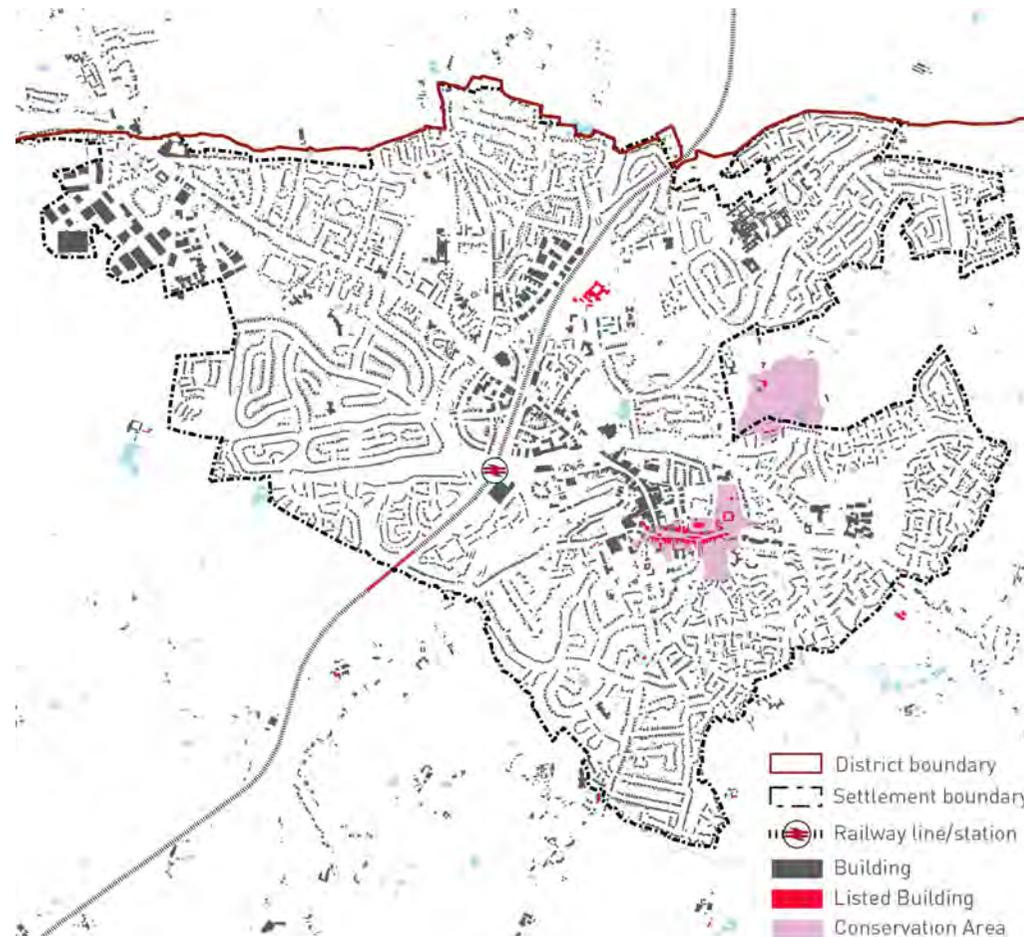

Figure 2K: East Grinstead - heritage

### Development Opportunities

2.6.29 Most development opportunities lie in the coarse grain areas (as defined in paragraphs 2.5.9 to 2.5.11). The western part of the centre includes unexceptional post-war development that contribute little to the town’s streets and spaces.

2.6.30 These areas are less sensitive to change and carefully designed schemes that are sympathetic to the historic centre, should help to strengthen the urban fabric and bring additional life in this part of the town (refer to chapter 5 - Site Optimisation).

## 2 Understanding the Context Site Appraisal



### 2.7 Site Appraisal

#### Principle DG2: Site appraisal

Having identified planning designations relevant to their site and prepared a Character Study, applicants should then carry out a Site Appraisal that identify and illustrates the physical aspects of their site, including topography, drainage, existing natural features, and access points (refer to fuller checklist at the end of chapter 2) to identify the key constraints and opportunities that will help to inform their proposal.

The Site Appraisal will form part of the Design and Access Statement that supports a planning application (including outline, full or reserved matters applications) and will include proposal drawings, supporting text and illustrations that demonstrate that the site appraisal has been comprehensively undertaken.

2.7.1 The objective of this Site Appraisal is to identify, in spatial terms, those constraints that will influence the design and the opportunities afforded by the site.

2.7.2 The scope and areas covered in the Site Appraisal should be related to the scale of the development proposals.

2.7.3 The checklist at the end of the Chapter provides guidance on the appropriate scope and subject areas for the Site Appraisal. This should not be considered as an exhaustive list of the constraints and opportunities but rather a starting point for consideration.



Figure 2L: Illustration of a typical appraisal (image courtesy of PRP Architects)

## 2 Understanding the Context

### Character Study CHECKLIST

#### How to use

This table provides a checklist of things to consider when preparing a **Character Study**.

The checklist should be used by applicants and planning officers as prompts when preparing the Character Study.

SUBJECT	DESCRIPTION	CONSIDERATION	CHECK
<b>Wider setting</b>	What is the wider setting of the site and the location of the settlement in relation to other settlements within the region?	Function of the settlement and relationship to adjacent areas	
	What is the wider context within which the site is located?	Settlement + site context	
<b>Settlement structure</b>	How is the settlement within which the site is located structured and where does it connect to? Does it have a linear structure along a main route or is part of a grid of streets for example?	Historical development	
	What is the existing hierarchy and network of streets and spaces within the settlement and how does this contribute to its character?	Structure and hierarchy of streets and spaces	
	Are there any places or uses that provide a focus for the settlement?	Identity	
	What is the prevailing density of the settlement? Does it vary and what would be appropriate for the application site?	Density of development	
	How does the existing settlement mark arrival points or the meeting of routes? Can this be drawn upon to mark gateways and nodes within the proposal?	Gateways and nodes	
	How large are existing plots or blocks within the settlement? Is the pattern regular or irregular?	Plot and block size	
<b>Landscape character/ natural features/ topography</b>	What is the broad landscape character, the underlying geology and how might this influence the development? Are there particular landscape, arboricultural, ecological or geological characteristics, for instance, that give a place its essential character?	Landscape and settlement character	
	Are there landscape features (trees, hedgerows, ecological or geological), within the site that give the place its character and can these be incorporated into the proposals?	Existing landscape features, water features, trees, hedges	
	Are there any important views to and from the site and beyond that are valuable and should be retained? Understanding how the new development will be perceived from the surrounding area.	Views and skyline	
<b>Streets and public spaces</b>	What is the prevailing level of enclosure for existing street types within the settlement? Does this contribute to their character? How are spaces enclosed?	The containment of streets and public open spaces	
	Are there particular public realm characteristics, such as planting, form, materials to draw influence from?	Layout and form of spaces	
	How does the interface between private and public spaces contribute to the settlement's character?	Public and private space interface	
	How does public art contribute to the settlement's character?	Public art	
<b>Built character</b>	What is the local built character and how does this provide cues for appropriate design forms?	Scale, form and massing	
	Does the building frontage define the public realm or are there front gardens? What are the prevailing boundary treatments?	Treatment of building frontages and boundaries	
	Are there common building types prevalent within the settlement? Can these be re-interpreted?	Building types	
	Are there common building materials within the settlement which would be relevant to the proposal?	Use of materials	

## 2 Understanding the Context

### Site Appraisal CHECKLIST

#### How to use

This table provides a checklist of things to consider when preparing a **Site Appraisal**. The checklist should be used by applicants and planning officers as prompts to identify **Constraints and Opportunities** for all sites.

SUBJECT	COMPONENT	SITE APPRAISAL	CHECK
Physical Environment	Topography and views	What is the topography of the site and how will this influence the proposals? How is the site viewed or overlooked from afar? Are there prominent overlooked areas that may be best left undeveloped? How can the development provide a well-defined external image to the countryside?	
	Geology and ground conditions	What is the existing geology of the site? Are there areas of the site which are difficult to build on, contaminated or less porous than others?	
	Orientation and microclimate	How is the site orientated? Can this be capitalised on?	
	Air quality, noise	Are there areas of the site which are affected by noise or poor air quality such as adjacent to major strategic roads or rail infrastructure or existing cultural or community buildings?	
	Drainage and hydrology	How does the site currently drain? Are there locations where water collects? Are soils permeable? How will this affect the proposals and the potential for sustainable urban drainage systems?	
	Flooding	Are there areas of the site within the flood plain? Are there areas of the site prone to flooding?	
	Services	Are there existing services and/or capacity to serve the development? Are there any existing utilities or service infrastructure that may constrain your development. For instance overhead power lines or a significant sewer.	
Heritage	Archaeology	Are there likely to be any archeological remains within the area? Is an archeology study required?	
	Historic assets	Are there any historic assets on the site or does the site form the setting of a Heritage Asset?	
Landscape	Tree Protection Orders (TPOs)	Are there any TPO's on the site?	
	Existing features	Are there any existing features such as trees, hedgerows, watercourses, or areas of woodland that have value and should be retained?	
	Ecology and biodiversity	What is the existing ecological and biodiversity value of the site? Are there particular areas or features which have a high ecological/biodiversity value that should be protected? Is there opportunity for habitat creation and enhancement?	
Highways	Access	What are the existing access arrangements for the site? Does an alternative means of access have to be introduced?	
	Connections and Links	Are there existing rights of way across the site? Can the site connect back to an existing neighbourhood and be integrated with an existing street network?	

## 2 Understanding the Context CHECKLIST

### How to use

This table provides a checklist for use by both the applicant and planning officer to check that appropriate consideration has been given to how an application **responds to its setting**.

**PROCESS:** Have you:

- Identified all planning designations;
- Considered the character of the site within its settlement and prepared a Character Study; and
- Carried out a detailed Site Appraisal and established the constraints and opportunities that apply to the site.

**PROCESS:** The adjacent table summarises the key principles set out within this section and can be used by both the applicant and officer as a checklist.

PRINCIPLE	DESCRIPTION	CHECK
<b>DG1: Character Study</b>	Has the applicant clearly identified whether the site lies within or adjacent to any area with a statutory or non-statutory planning designation?	
	Has the applicant understood the implications of these designations on the development of the site?	
	Has the applicant carried out a Character Study and covered the topics set out in the relevant checklist?	
	Has the applicants Character Study included an evaluation of the landscape character of their site and its setting?	
	Has the applicant identified the potential opportunities for new development to make a positive contribution to the character of a settlement?	
<b>DG2: Site Appraisal</b>	Has the applicant prepared a detailed Site Appraisal and identified the constraints and opportunities that apply to their site?	

**SUMMARY:** At this stage the applicant should have a full understanding of their site and its context. This work should be undertaken before developing design proposals.



# 3 Establishing the Structure



# 3 Establishing the Structure Natural Resources

## 3.1 Introduction

3.1.1 Chapter 3 is divided into three parts that show how applicants can translate their understanding of a site's context into the establishment of a coherent layout structure for their proposed development. It sets out design principles (illustrated by an indicative concept plan) that demonstrate how existing natural features, built form, and key links, should all contribute to shaping the layout structure. This approach is key to delivering development that embodies a strong sense of place and local identity, while also providing good connectivity which helps to deliver a sustainable transport strategy that prioritises pedestrian and cycle movement. By identifying a green infrastructure network and drainage strategy at the outset, it also helps safeguard the ecology and areas for local recreation as well as protecting the site from the threat of flooding.

## 3.2 Natural Resources

### Principle DG3: Work with the site's natural features and resources

The landscape characteristics should be considered from the outset of the design process. The existing natural landscape informs the existing character of most sites. It should be retained as much as possible so that it shapes the form of new development and is incorporated to enhance its setting while reducing its impact on the wider landscape. This includes the consideration of the topography, trees and vegetation, orientation, landform, geology, watercourses / drainage, field patterns, boundaries and ecology.

The integration of the natural features provides the basis for a green infrastructure network that should underlie new schemes and enable them to contribute positively to the sustainability agenda and give them a sense of place, while also reducing the impact of the built form on the wider landscape.

The provision of green infrastructure is increasingly important in addressing the effects of climate change as it can help mitigate flooding, maintain biodiversity and play a role in reducing urban air temperatures. Green infrastructure also encourages healthy lifestyles by enabling outdoor activities.

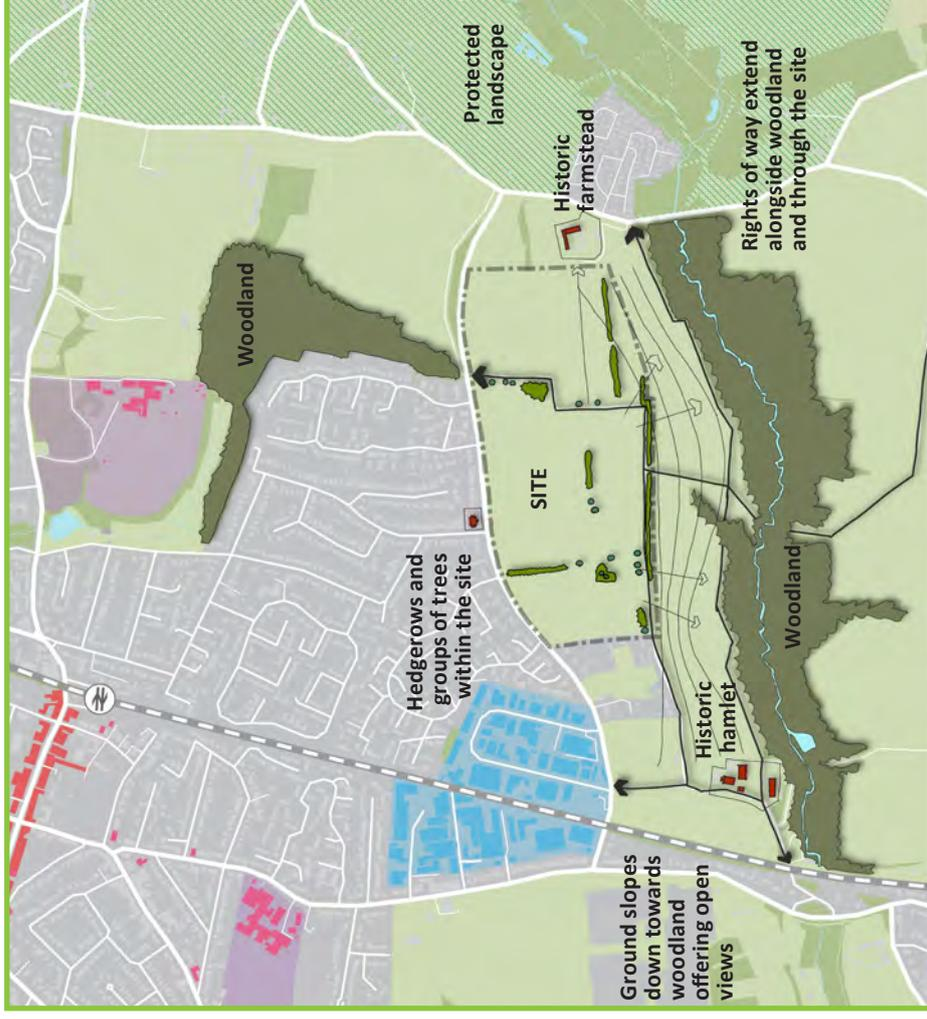

Figure 3A: INDICATIVE SITE CONCEPT PLAN 1 - Identifying natural features and resources

### 3 Establishing the Structure Natural Resources



Central open space, Chalkers Lane, Hurstpierpoint

#### Principle DG4: Establish a landscape and green infrastructure network

The shape and form of open space should be positively planned at the outset and inform the layout of new development.

Open space should normally be provided as:

- An integral part of new development and should be located where it is safe, most accessible and central to a scheme rather than isolated towards the edge; and
- Part of a coherent landscape structure and linked to existing and proposed landscapes to form open space networks whenever possible, revealing existing landscape features.

New open spaces should maximise the opportunity to accommodate landscape features such as mature trees and water courses / ponds, while fulfilling drainage requirements (refer also to chapter 4 section 4.9 for guidance on the design of open spaces).

REFERENCES  
Principles DG25 to DG30

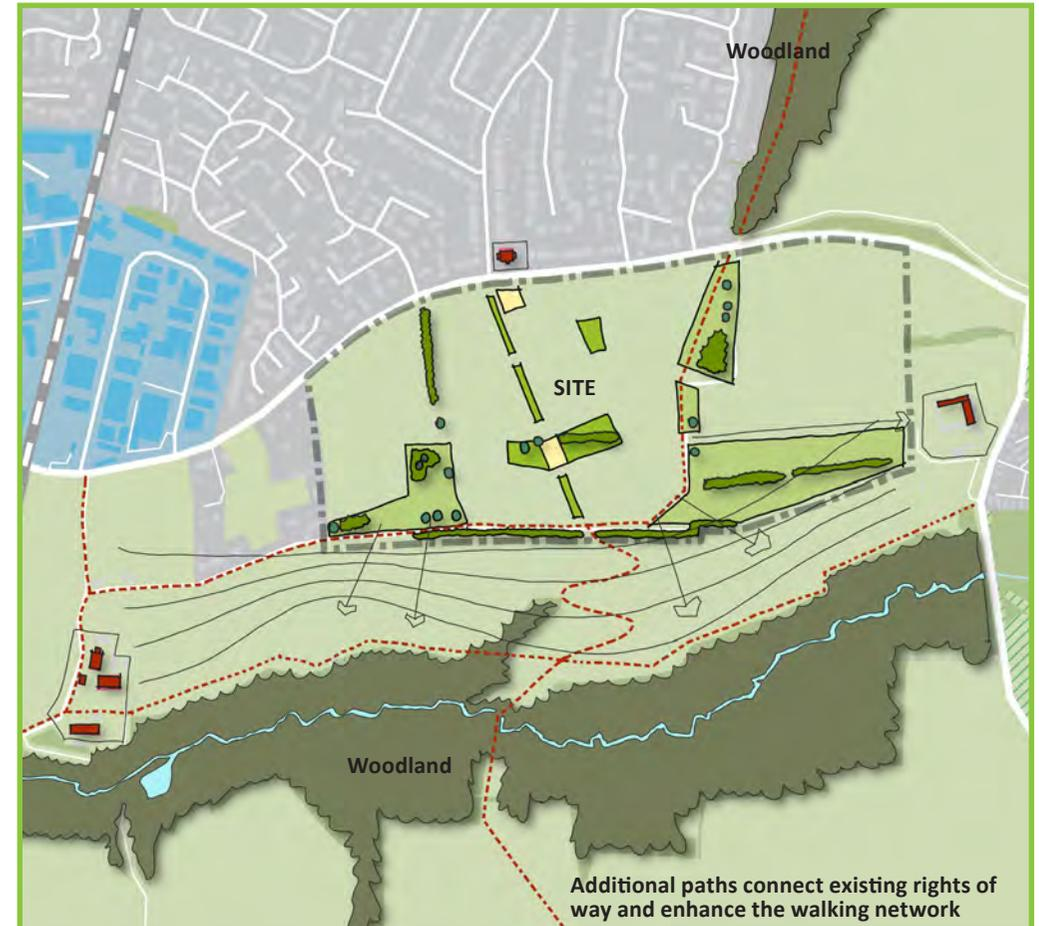

Figure 3B: INDICATIVE SITE CONCEPT PLAN 2 - Establishing a landscape strategy  
A network of connected open spaces is proposed through the site. These are strategically located to:

- Maximise the benefits of existing green infrastructure
- Provide open spaces within the heart of the new development
- Respond to, and soften the impact of development on existing heritage assets; and
- Link areas of woodland to the north and south of the site

### 3 Establishing the Structure Natural Resources

#### Principle DG5: Water features and sustainable drainage systems

Whenever possible applicants should retain, enhance or re-establish watercourses and other surface waterbodies as positive features contributing to the character, sense of place, ecological value and biodiversity of new development.

Applicants should consider how to manage surface water to minimise flood risk and flows to watercourses. Development proposals should normally incorporate sustainable urban drainage (SuDs) as an integral part of the landscape structure.

SuDs should be positively designed into schemes from the outset as public realm features. These features can include ponds, infiltration basins, swales/rain gardens and wetlands as they:

- Help manage the risk of flooding and climate change;
- Reduce demand on the sewer network;
- Manage some pollutants and improve the quality of water going back into the environment; and
- Can make a positive contribution to the biodiversity, character, appearance and sustainable performance of development.

Swales and attenuation ponds should be designed so that water features and plants are visible from the surrounding area and should avoid unattractive boundary treatments or engineered surrounds. Attenuation ponds on slopes should be avoided if they need deep embankments or bunding.

Consideration must be given to the future management and maintenance of sustainable drainage otherwise flood risk could increase.

The choice of surface materials and the balance of hard and soft landscaping should be considered in terms of the impact upon the drainage system. Where hard landscaping is needed, porous materials should normally be maximised to enable infiltration and manage rainfall at source.



A waterbody provides an attractive setting on Lindfield High Street



SuDs feature at Maltings Park, Burgess Hill



An appropriately domestic scaled attenuation pond



Storm water planters can be incorporated within the street design to attenuate rainwater



SuDs feature integrated within the streetscene in Upton, Northampton

# 3 Establishing the Structure Best Practice Case Study

## Case Study One: Imberhorne Lane, East Grinstead

### *Working with the natural resources of the site*

#### Overview

This scheme responds well to its woodland setting. The scheme is developed into the landscape and organised around centrally positioned open spaces which incorporate existing trees. The houses are arranged as loose perimeter blocks that look onto and define open spaces and groups of mature trees, both on the boundaries and within the heart of the site.

The buildings have a positive relationship with the boundaries facing towards open countryside to the west and Imberhorne Lane to the east. SuDs are incorporated within the spaces.

Whilst the homes and public realm are well detailed, it is the sensitive and positive response to the landscape that distinguishes the development and provides a sense of place.



**Architect:** JTP Architects

**Site area:** 5.53 Hectares

**Number of Homes:** 110

**Density:** 20 homes per hectare



### 3 Establishing the Structure Natural Resources

#### Principle DG6: Design to enhance biodiversity

Biodiversity is threatened by habitat loss and fragmentation, unsustainable resource use, introduction of invasive species, pollution, and global climate change. Ecosystems nevertheless provide crucial services such as pollination, seed dispersal, climate regulation, water purification, nutrient cycling, and control of agricultural pests. Many studies have also found links between human well-being and access to nature and the countryside.

The District has valued landscapes, habitats and species which need to be protected and enhanced. District Plan policy DP38 requires that development will improve, enhance, manage and restore biodiversity and green infrastructure, so that there is a net gain in biodiversity.

New development should establish ecological networks that are more resilient to current and future pressures. Landscape features that have high biodiversity/ecological value should normally be retained and incorporated within proposals and consideration given to the creation of new habitats.

Hedges, wildflower meadows, wild corners, old trees, ponds, hard landscaping features such as dry stone walls and rock piles and nest boxes installed in the eaves of buildings can all make a significant contribution to species diversity.

New planting and landscapes should respond to the wider landscape through use of native species that support greater biodiversity and provision of areas of wildflower meadows.



Wetland area at Clayton Mills, Hassocks



Housing adjacent to protected woodland



### 3 Establishing the Structure Topography and Views



View across Mid Sussex towards the South Downs

#### **Principle DG7: Respond to topography and strategic views**

Views across the open countryside from elevated locations in the District, especially in the High Weald and South Downs National Park, are an important part of the District's character and must be retained. Developments, particularly at a larger scale, must be carefully managed to minimise adverse impacts. New buildings should not obscure or cause adverse impact on these existing views and attention must be given to reduce the impact of development against the skyline or ridgelines of hills.

Development proposals should soften their appearance within the landscape by minimising their visual impact through integrating them within the existing landform and with the careful siting of buildings and landscape.

Applicants should identify important views into and out of their site. This may include long distance views to landscape features or buildings or shorter distance views to attractive or distinctive townscape. Where appropriate development should be laid out so that these views are retained and where possible enhanced to improve legibility whilst ensuring that new development is appropriately screened so as not to impact on views towards the site.

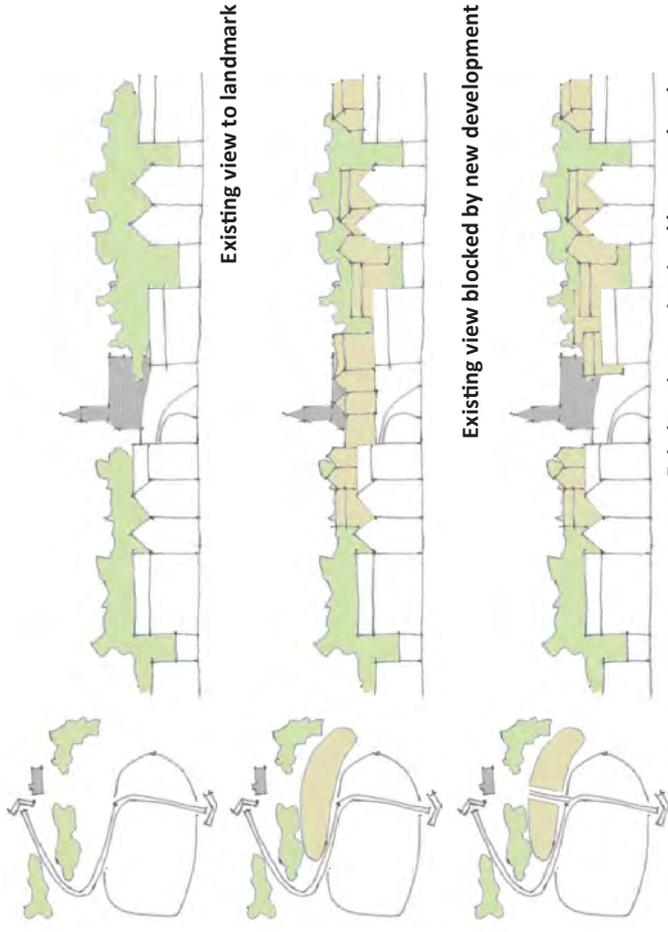

Figure 3C: Landmarks and views



View across Mid Sussex from the South Downs

# 3 Establishing the Structure Movement Network

## 3.3 Movement Network

### Principle DG8: Establish a clear movement network that connects with the surrounding area

Successful places are easy to get to, easy to move through and easy to find your way around. A connected network of streets offers choice, aids legibility, avoids engineered solutions and provides a hierarchy of street types which respond to the function and role of the street. The layout of new development should therefore:

- Link with existing routes and access points;
- Create direct, attractive and safe connections through the site for pedestrians, cyclists and vehicular modes which follow natural desire lines, connect to existing streets, open spaces, local facilities or destinations, and coordinate with open spaces and green links;
- Avoid turning heads by creating continuous vehicular routes around perimeter blocks;
- Carefully integrate public rights of way; and
- Sensitively accommodate the existing topography while avoiding steep gradients.

The network should provide a choice of routes for all modes and follow a spatial and visual hierarchy. The character of a street should reflect its position in this hierarchy and respond to local characteristics (refer to DG1).

While direct routes are most convenient, the design should also balance visual attraction, traffic calming and safety to optimise the pedestrian's experience.

Applicants should avoid promoting developments that are accessed off a single location or promote a long cul-de-sac that do not provide a choice of direct and convenient routes.

The opportunity should be taken to make pedestrian / cycle connections between adjacent development sites.

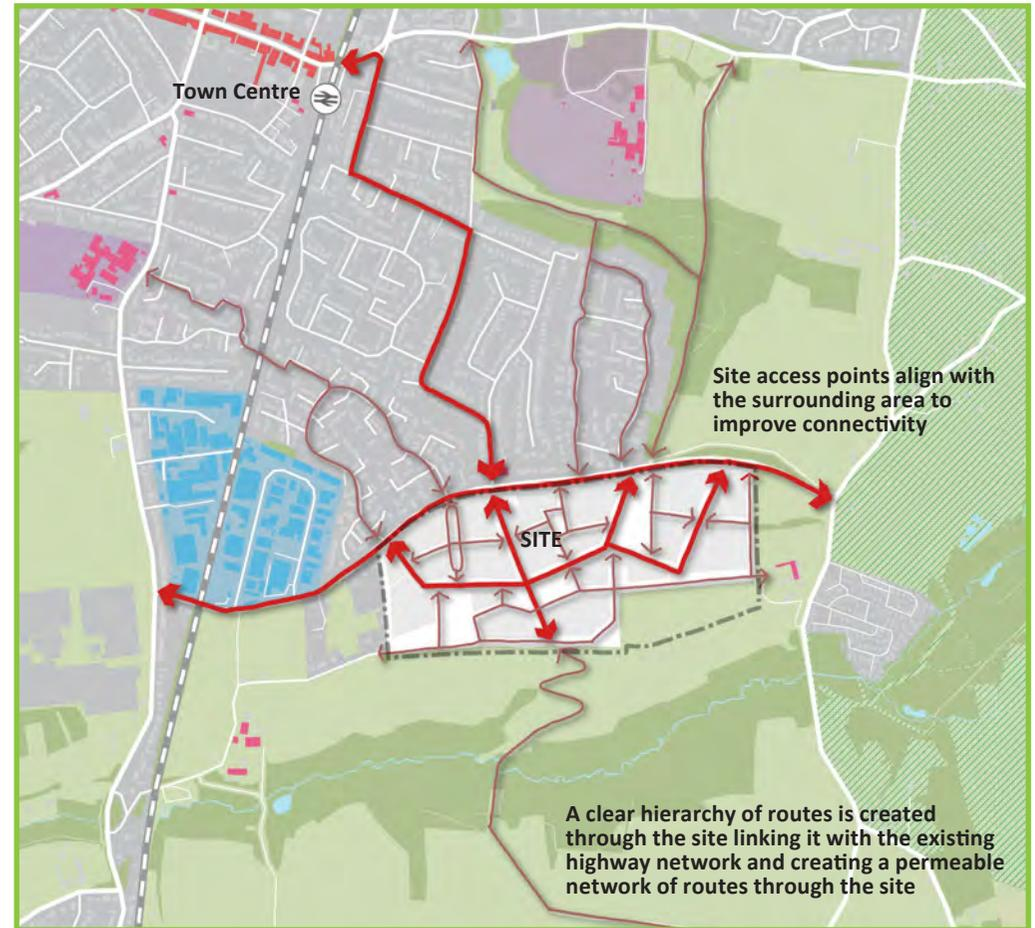

Figure 3D: INDICATIVE SITE CONCEPT PLAN 3 - Establishing a clear movement network

### 3 Establishing the Structure Movement Network



#### Principle DG9: Reduce reliance on the private car

New development should be designed to encourage active lifestyles and sustainable modes of transport prioritising the needs of the most vulnerable road users first, in accordance with the recommendations in Manual for Streets.

Applicants should accordingly plan their development to minimise reliance on the private car. They should create an attractive network of safe and convenient pedestrian and cycle routes integrated with the development and connecting with the wider area and adjacent sites.

Public transport should also be accommodated where appropriate. For larger developments (over 300 homes) applicants should consider at the outset how buses can be routed through a site and the provision of stops in the most accessible locations where they may serve both new and existing residents. This will inform consideration of street design at the more detailed design stage. Whenever possible new homes should be located within 400m (approximately a 5 minute walk) of a bus stop.

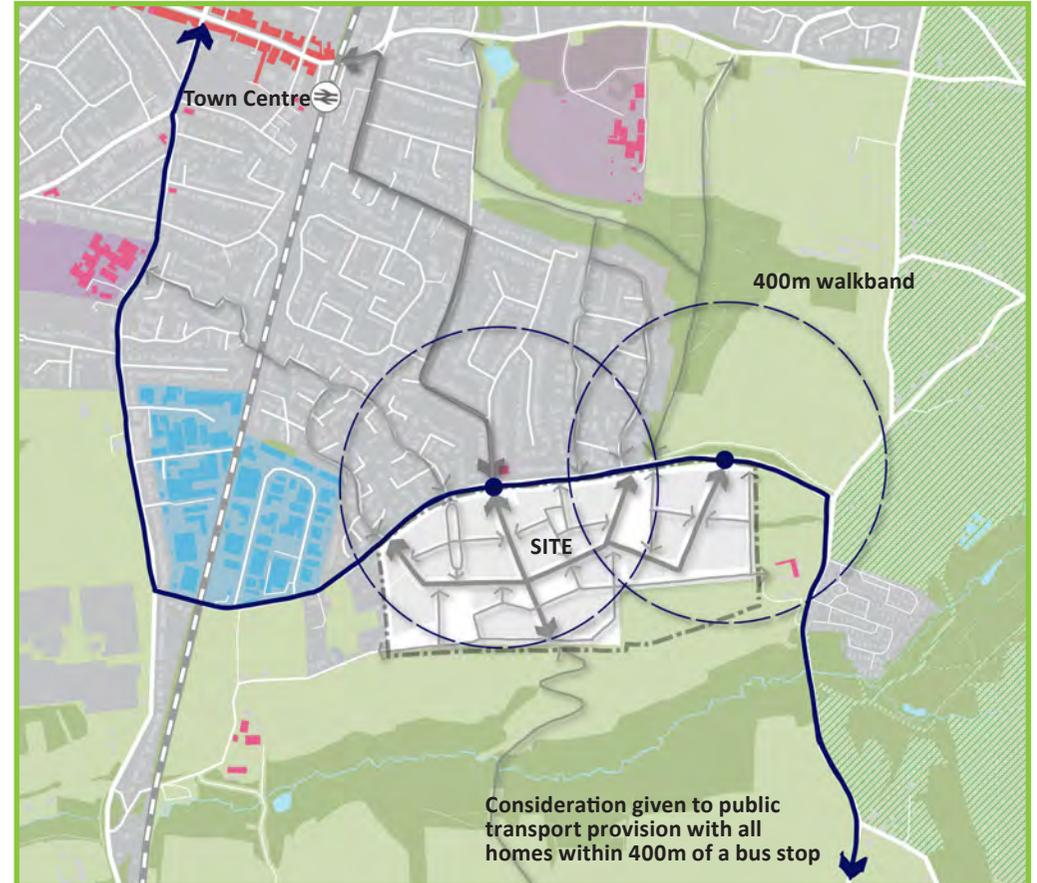

Figure 3E: INDICATIVE SITE CONCEPT PLAN 4 - Accommodating public transport within the proposal

Consider first ↓ Consider last	Pedestrians
	Cyclists
	Public transport users
	Specialist service vehicles (eg emergency services, waste, etc)
	Other motor traffic

Figure 3F: User hierarchy from Manual for Streets

### 3 Establishing the Structure Movement Network



#### Principle DG10: Anticipate future development

The movement network / layout should be future-proofed by providing streets that later phases of development can connect into at the edges of development sites (and by avoiding a network of cul-de-sacs accessed off a distributor route).

This is typically achieved by a combination of:

- Legible links through the site; and
- Perimeter block layouts that generate roads around the perimeter of the site and building frontages that face the boundaries.



Figure 3G: INDICATIVE SITE CONCEPT PLAN 5 - Scheme is laid out to allow for further development phases in the future

# 3 Establishing the Structure Townscape and Heritage



## 3.4 Existing Townscape and Heritage

### Principle DG11: Respond to the existing townscape, heritage assets and historic landscapes

Heritage assets and historic landscapes should be celebrated, enhanced and preserved where appropriate, for the enjoyment of existing and future residents.

Where appropriate and providing it does not cause harm to the heritage assets or their setting, they should be carefully integrated into development proposals as they help to reinforce a sense of place and local identity.

Elsewhere new development should generally reflect the scale of adjacent areas and the settlement context within which it is located to deliver a coherent and consistent urban fabric.

There may be potential to introduce a new character / development form and massing (refer to chapter 5):

- On larger urban extensions; this will typically be within the middle of the site and associated with a new neighbourhood centre, spine road or the main open space.
- In town centre locations defined as coarse grain areas and nearby sites identified on the brownfield sites register.



Figure 3H: INDICATIVE SITE CONCEPT PLAN 6 - Scheme responding to existing townscape and heritage

# 3 Establishing the Structure Best Practice Case Study

## Case Study Two: St Margarets, East Grinstead

### *Responding to townscape and heritage*

#### Overview

This scheme has been formally laid out and structured to respond to the Grade 1 listed St Margaret's Convent. Dwellings are arranged as formal terraces that face each other on both sides of an axis focusing directly onto the Convent.

This celebrates the cluster of convent buildings and provides a strong point of reference in the townscape. The gable frontages and materials palette used for housing facades also references the sandstone and gables employed in the convent buildings.

Elsewhere the houses are laid out to form quadrants that reflect the collegiate arrangements within the Convent.

**Architect:** Clague Architects

**Site area:** 2.97 Hectares

**Number of Homes:** 74

**Density:** 25 homes per hectare



# 3 Establishing the Structure CHECKLIST

## How to use

This table provides a checklist for use by both the applicant and planning officer to check that appropriate consideration has been given to how an application has established the **structure** of the proposal.

**PROCESS:** Have you read, understood and applied the principles set out through Section 3?

**PROCESS:** Have these principles been considered in conjunction with the Planning Designations, Character Study and Site Appraisal prepared in Response to the Site and Setting in Section 2?

**PROCESS:** The adjacent table summarises the key principles set out within this section and can be used by applicants and officers as a checklist.

The applicant is expected to meet the requirements of all relevant Principles (ie a tick in each box) or provide a justification for failure to do so.

PRINCIPLE	DESCRIPTION	CHECK
<b>DG3 and 4: Natural Resources</b>	Has the design proposal used the physical characteristics of the site identified in Section 2 to influence the form and layout of new development?	
	Has the proposal maximised the site resources in response to Principles DG3 and DG4?	
<b>DG5: Water Features and SuDs</b>	Where applicable has the design sought to retain, enhance and/or re-establish surface water features identified in Section 2 as positive features?	
	Has the design incorporated the use of sustainable urban drainage as an integral part of the layout and landscape structure?	
<b>DG6: Ecology and Biodiversity</b>	Have landscape features with high biodiversity/ecological value identified in Stage 2 been retained and incorporated within the proposals?	
	Do the proposals deliver net biodiversity gain?	
	Have new habitats been created within the landscape structure to encourage additional species?	
<b>DG7: Topography and Strategic Views</b>	Does the design work with the topography and integrate the buildings within the landscape?	
	Have important views been identified and does the layout of development respond appropriately to these?	
<b>DG8: Connect with the Existing</b>	Does the proposal integrate with existing routes and access points, and create direct and attractive connections through the site for pedestrians, cyclists and vehicular modes?	
	Does this movement network respond to topography and landscape features and integrate public rights of way?	
<b>DG9: Reduce the Reliance on the Car</b>	Does the proposal prioritise the needs of the most vulnerable road users first creating an attractive network of safe and convenient pedestrian and cycle routes?	
	Does the proposal incorporate space for public transport where appropriate?	
<b>DG10: Anticipate Future Development</b>	Is the design future proofed by providing streets that later phases of development can connect into at the edge?	
<b>DG11: Heritage Assets and the Historic Landscape</b>	Does the design respond to, celebrate, enhance and preserve any heritage assets and historic landscapes within the proposals?	



# 4 Site Layout, Streets and Spaces



# 4 Site Layout, Streets and Spaces

## Urban Structure

### 4.1 Introduction

4.1.1 Well-designed streets and public spaces contribute significantly to the success of places and to the sustainability agenda. Streets and public spaces should be laid out to support both well-being and environmentally-friendly transport by:

- Being safe, comfortable, stimulating and attractive environments that encourage social interaction, act as meeting points for communities; and
- Encouraging sustainable transport modes and healthy lifestyles that reduce reliance on the car. This is also helped through the creation of attractive environments for pedestrians and cyclists.

4.1.2 The guidance in this chapter will help applicants to develop the structure of their development into a more detailed layout emphasising the importance of the public realm as well as the design of social spaces that contribute to the success of an area.



Figure 4A: INDICATIVE SITE CONCEPT PLAN 7 - Delivering a clear structure of streets and spaces

### 4.2 Urban Structure - Perimeter Block

#### Principle DG12: Deliver a clear and connected structure of streets and spaces

Applicants should promote an urban structure to their development that is easy to understand and where there is a clear street hierarchy and network of open spaces. To help achieve this development should create a grid network of streets and perimeter blocks which may be regular or irregular in form. The perimeter block is most appropriate for achieving successful development as it:

- Optimises connections to surrounding areas;
- Provides a clear distinction between public and private spaces;
- Enhances permeability and legibility;
- Generates building frontages that face the street and thereby increases natural surveillance and activity on the street;
- Creates secure and private rear gardens and elevations;
- Can work at any scale or location; and
- Ensures attractive street frontages.

The block size and shape will vary according to the density of development, location within the District and mix of uses. In general, blocks between 50 - 120 metres in length provide a permeable network for both pedestrians and vehicles. The blocks form and size should also account for natural features, orientation and topography as well as providing enough back-to-back distances to provide residential amenity. Bigger blocks are appropriate where rear court parking is accommodated.

The blocks within the grid may be regular shaped squares or rectangles (providing a regular grid), as found in many new towns, or they may be more irregularly shaped as found in historic towns and villages.

# 4 Site Layout, Streets and Spaces

## Urban Structure

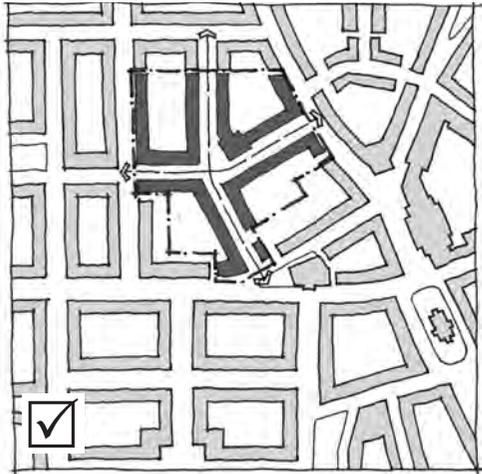

Figure 4B: Development proposes a connected network of streets with blocks contributing to the existing pattern

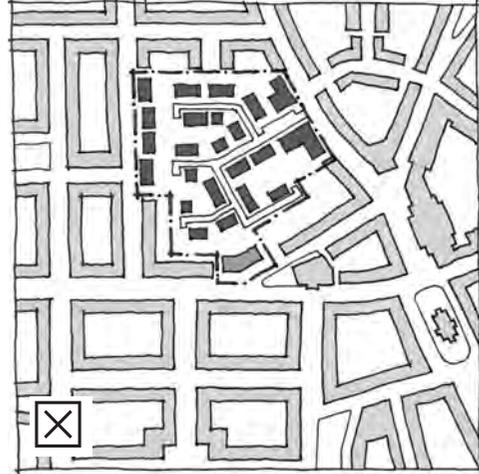

Figure 4C: Development proposal is internalised with new buildings accessed via cul-de-sac streets



The layout of housing at Newton Road, Lindfield is arranged as a series of perimeter blocks (image courtesy of Google maps)

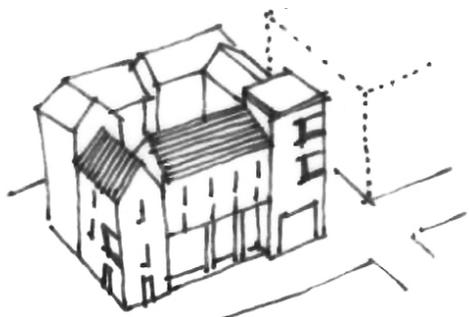

Figure 4D: Higher density, urban blocks are suitable in more urban locations

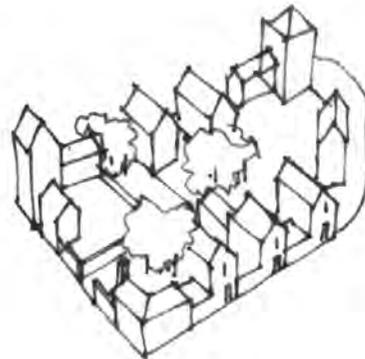

Figure 4E: Lower density, blocks are more suitable in rural locations

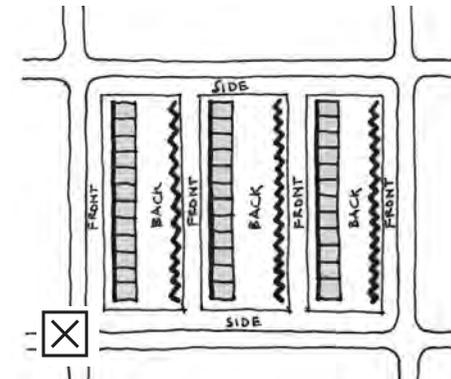

Figure 4F: Streets should not mix fronts and backs

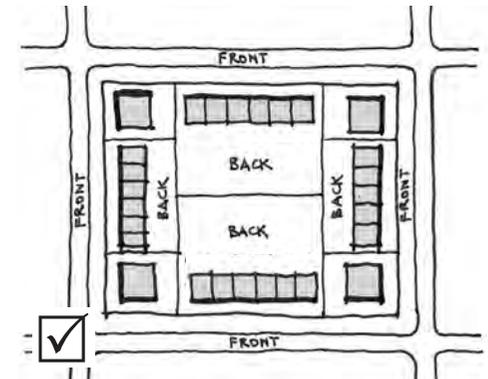

Figure 4G: Perimeter block layout ensuring a clear definition of front and backs and a strong building line to the street

# 4 Site Layout, Streets and Spaces

## Street Enclosure

### 4.3 Urban Structure – Positive Frontages

#### Principle DG13: Provide positive frontage to streets

New development should normally provide strong street enclosure and continuous frontages that enable coherent building lines with the corners of blocks emphasised. Within urban areas, the established existing building line should usually be followed.

Buildings should be arranged with public areas to the front so that buildings overlook and provide natural surveillance to streets and open spaces minimising opportunities for crime. This also allows for secure private areas at the rear.

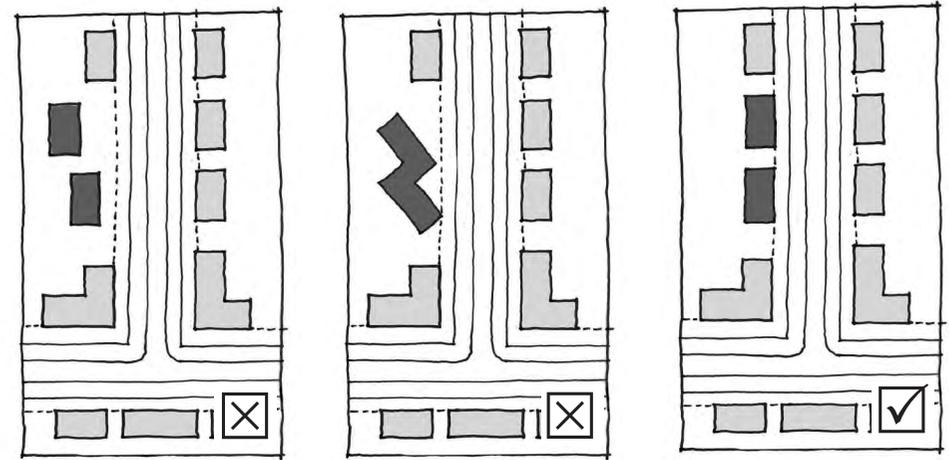

Figure 4H: New buildings in a street should follow the established building line



Inconsistent building lines often weaken street enclosure and reveal blank flanks



Houses that back on to the street unattractively expose their rear boundaries; this provides no animation or natural surveillance of the public realm while the gardens are subjected to traffic noise



Exposed blank flanks to buildings fail to address the street



The chamfered corner ensures a continuous street frontage that overlooks and addresses the corner

# 4 Site Layout, Streets and Spaces

## Street Enclosure

### 4.4 Urban Structure - Enclosure

#### Principle DG14: Provide enclosure

Proposals should provide a sense of enclosure appropriate to the role of the street within the hierarchy of the layout. This will help to create a sense of place and reinforce the legibility of the development.

The distance between facing building frontages across the width of the street, together with the height of the buildings and the gaps in the frontage determines the level of enclosure that is experienced within the street. Human-scaled streets can normally be achieved through increased levels of enclosure (typical of historic developments that pre-date the motor car) by setting buildings close to the street edge (responding to pedestrian rather than car movements). Creating a sense of enclosure on a main street through a development may require an increase in building height to balance the increased building to building distance that may be necessary to accommodate wider carriageway and pedestrian/cycle provision.

Enclosure is sometimes defined by landscape as much as buildings with trees, hedges and walls contributing towards creating a sense of enclosure.

Development should be appropriate to people rather than cars. Streets and spaces that do not provide adequate enclosure or are dominated by roads or parking will not be acceptable. The space between buildings should be well defined but not oppressive. As a rough guideline, a ratio of between 1:1.5 to 1:3 (height: width) is likely to be appropriate depending on the hierarchy of street or public space (Refer to the Urban Design Compendium).

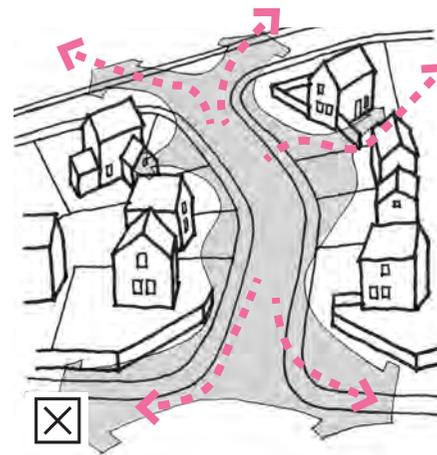

Figure 4I: Road dominated: lack of enclosure

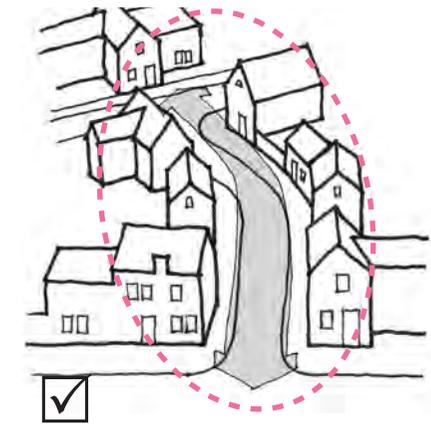

Figure 4J: Place focused: enclosure provided by buildings creates a better street environment



Housing at Newton Road, Lindfield positively fronts onto and encloses the street space



Strong street enclosure provided by consistent building lines and 3/4 storey frontages



Houses of modest height set-back from the street typically generates weak street enclosure and an environment that is dominated by parking



A set-back frontage generates weak street enclosure particularly when it is not compensated by trees/ soft landscaping and is instead dominated by parking and hard-standing

## 4 Site Layout, Streets and Spaces Legibility and Image



### 4.5 Legibility and Image

#### Principle DG15: Use markers, landmarks, vistas and street hierarchy to aid legibility

Landscape features or special buildings/structures can help to add distinctiveness to a place and act as visual cues to aid legibility and understanding. New developments should enhance legibility by laying out development to respond to such existing features or through the careful location of new features or buildings to act as markers or landmarks. For larger schemes development should be laid out with a clear street hierarchy that allows users to easily distinguish main streets from secondary and minor routes.

Streets that create a varied sequence of spaces and vistas aligned with focal buildings can be more rewarding and contribute to the understanding of a place. This can be achieved through:

- A curve or kink in the street;
- Off-setting the street network and terminating the view on a building;
- Creating a pinch point; and/or
- Locating a taller building to terminate the street which marks the end of an axis.

Marker buildings may be a little taller than the surrounding context but this increase in height must be proportionate to the role that they play in the streetscape.

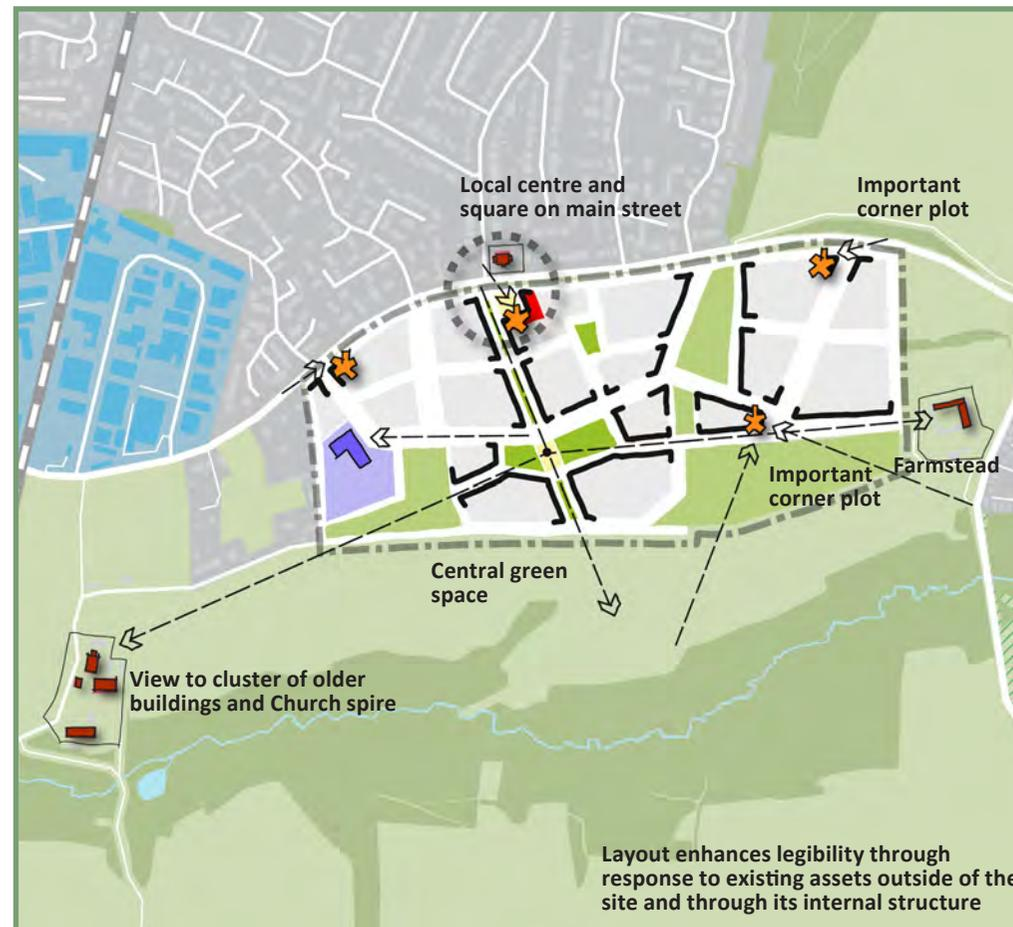

Figure 4K: INDICATIVE SITE CONCEPT PLAN 8 - Enhancing legibility

## 4 Site Layout, Streets and Spaces Development Edge

### Principle DG16: Create a positive development edge

Properties should not back onto the settlement edge and the edge should not be defined by rear garden fences. This can create security problems and over time the quality of the environment can become degraded as fences are replaced or fall into disrepair. When viewed from the countryside this creates an unresolved and untidy edge that diminishes the quality of the environment.

Developments should therefore normally be designed with building frontages facing site boundaries served by new access roads that run adjacent to the site edge. This arrangement also enables existing tree-lined boundaries and hedgerows to be:

- Revealed to the public realm; and
- Safeguarded by incorporating them outside the private realm and avoiding potential overshadowing of rear gardens.

Development should nevertheless be sensitively designed so that it avoids imposing upon the rural edge and existing roads that are characterised by their hedgerows and tree belt. This may require additional boundary planting. At the rural edge lower density development will also normally be necessary.



Development that present a positive development edge with the countryside (ABOVE and TOP)



The edges of development should respond positively to the existing landscape and avoid fences abutting the countryside

# 4 Site Layout, Streets and Spaces

## Pedestrian Friendly Streets

### 4.6 Pedestrian Friendly Streets / Street Hierarchy

**Principle DG17: Provide attractive streets and spaces defined by buildings rather than the highway, that encourage low speeds and that are safe to use by everyone**

Streets should be designed as social spaces with the needs of pedestrians, cyclists and public transport users put above the needs of the motorist.

Within larger developments a clear street hierarchy should be promoted with the principal vehicular routes integrated within the structure of development as main streets or boulevards, fronted by buildings and with street trees and not as peripheral distributor roads (bypasses).

Streets should be well defined and enclosed by building frontages normally in combination with trees and landscaping and street design should encourage pedestrian and where possible cycle\* movement through:

- Appropriate pavement widths, avoiding unnecessary barriers or clutter;
- Providing places for pedestrians to rest, gather and socialise;
- Designing residential streets for maximum speeds of 20 miles per hour; and
- Traffic calming measures that are integral to the street design and not an imposed engineered solution to encourage drivers to drive with care and caution.

Traffic calming measures may include:

- The use of shared surfaces;
- Varying the alignment of the vehicular route;
- Use of tight junction radii;
- Narrowing the carriageway and the use of planting bays/ build-outs;
- The provision of on-street parking;
- Raised areas at junctions and nodal points; and
- Changes of surface colour and materials.

(\* Refer to [West Sussex Cycling Design Guide](#))



Newhall, Essex - A well design street with generous footways



Buildings provide a poor interface and definition of the street in Sayers Common



Streets with generous footways, tree planting and good overlooking from adjacent buildings feel safer to use

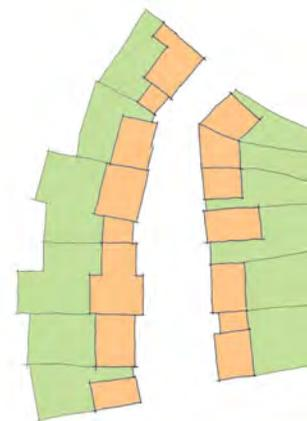

Priority should be given to buildings and enclosure



Minimize space given over to carriageway. Use the resulting space for hard or soft landscaping with parking as appropriate

Figure 4L: Design streets as social spaces

# 4 Site Layout, Streets and Spaces

## Pedestrian Friendly Streets



Successful shared surface street incorporating tree planting, soft landscaping and parking



Speed bumps as a traffic calming measure for new roads should be avoided.



Controlling traffic speeds through road narrowing at Bolnore, Haywards Heath

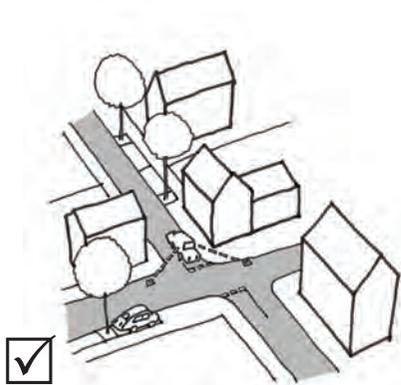

Figure 4M: Frequent changes in directions and tight corners with narrow sight lines to control speed

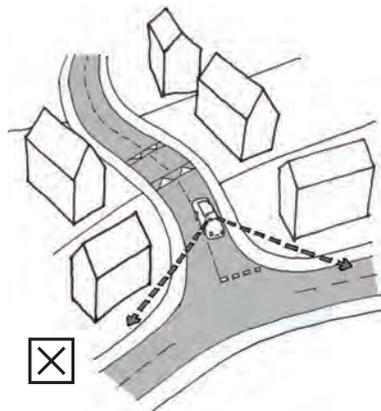

Figure 4N: 'Fast' road with gentle bends and wide sight lines controlled by speed bumps gives mixed messages and can encourage speed



Shared surface areas surfaced in clay pavers at Imberhorne Lane, East Grinstead



Traffic calming measures should be integrated within the design of streets

## 4 Site Layout, Streets and Spaces

### Parking



Attractive street incorporating trees and car parking

#### 4.7 Parking

##### Principle DG18: Integrate parking to support attractive streets and spaces

The quality of the street environment should be a paramount consideration in designing parking spaces into the street. Parking should be attractively integrated so that it does not dominate the streetscape, is softened by landscaping and accords with the other layout principles in the Guide.

A balanced approach should be taken to achieve convenient parking close to households whilst minimising the impact of parking on the street. Applicants should prepare a comprehensive car parking strategy which contains a combination of appropriate parking solutions with a balance of on-street and off-street parking provided (refer to District Plan policy DP21).

##### Car Clubs

Car clubs should be considered to reduce the level of parking, and as an alternative to a second car, particularly on larger schemes.



Front threshold parking reduces street enclosure and when combined with an absence of planting results in a bleak streetscape



Parking square broken up by mature planting which 'softens' the appearance of parked cars



Wychwood, Crawley Down - car parking is discretely located to the side of property



Undercroft tandem parking is space efficient and discreet enabling strong street enclosure



Pergolas and car barns can help to reduce the visual impact of parking and contribute positively to defining and enclosing streets and spaces



## 4 Site Layout, Streets and Spaces Parking

### Principle DG19: Provision of off-street parking

To achieve well defined streets with a good level of enclosure and avoid parking dominating streets, it will normally be necessary to accommodate off-street parking in new developments. These parking spaces should be discreetly incorporated, and preferably screened from the main public realm, so they do not contribute to a hard-edged / parking-dominated environment.

Higher density areas within new developments which incorporate terraced housing and flats should normally include rear court, under-croft or underground parking. Rear courts typically need to be small in scale (up to 15 spaces approximately) to avoid large soulless hard-edged environments. They should be designed so they benefit from direct overlooking while being well screened from the street; for these reasons, they work well when they are combined with flats over garages (FOG's) that define the street frontage. Entrances to rear parking courts should be carefully designed to create a semi-private appearance.

Larger parking courts/squares will normally be unacceptable unless they are designed as part of a well landscaped and ordered open space that contributes positively to the development.

For lower density areas with detached and semi-detached houses, parking should normally be discreetly accommodated to the side of dwellings, and behind the building line where it is less visible from the street. Tandem parking arrangements avoid over-wide separation gaps between buildings.

Off-street parking in front of houses should normally be avoided. This is likely to result in environments dominated by hard surfaces and generates greater face to face building distances leading to weaker street enclosure unless combined with taller building frontages.

### The Benefits of Flats over Garages (FOG's)



A FOG incorporating undercroft access to a rear parking court that is discreetly screened from the street by the building frontage



At the rear, the FOG provides direct natural surveillance over the parking court



An aerial image showing how the FOG both defines the street and screens rear court parking



The off-street parking courts ensures a pedestrian friendly environment where vehicles do not dominate and it also enables better defined streets that have a more village-like scale

### Examples of Poorly Organised Off Street Parking



This parking court is unattractively exposed to the street



Large parking courts should normally be avoided as they tend to be less self-policed and can result in a bleak environment

## 4 Site Layout, Streets and Spaces Parking

### Principle DG20: Integrate on-street parking

On-street parking is convenient and adds activity to the street and natural surveillance. It also avoids vehicle crossovers on the pedestrian footway. To avoid it dominating the street, on-street parking should be well landscaped and incorporate generous safeguarding areas around trees and shrubs to protect them from pedestrian as well as vehicular movement and provide for private defensible space at the front of dwellings.

On-street parking must be designed to minimise its visual impact. Parking bays are normally most discreetly laid out in parallel, rather than right-angles, with the street kerb.

Right-angle on-street parking should be minimised in new developments as it can dominate the public realm, generate weak street enclosure and hard-edged street environments. It is nevertheless sometimes acceptable providing it is positively designed as part of a comprehensive landscaped public realm and is limited to one part of a comprehensive parking strategy for the higher density areas.

On-street parking should not cause obstructions in the highway, enable free movement of refuse vehicles and buses while retaining continuous footways

### Non-allocated Parking

Non-allocated, shared parking (generally on street) is more efficient than designating parking to individual dwellings and this approach is encouraged to reduce parking numbers within development schemes especially in respect of terraced housing.



Figure 40: A good formal arrangement for a primary street that incorporates parallel parking with regular tree planting within kerb build outs reducing its impact on the street space (Section)



Figure 4P: A good formal arrangement for a primary street that incorporates parallel parking with regular tree planting within kerb build outs reducing its impact on the street space (Plan)



Parking is usually most unobtrusively accommodated on-street as parallel spaces softened and defined by tree planting



A mix of perpendicular and parallel parking may be possible but only if the street is well landscaped

# 4 Site Layout, Streets and Spaces

## Refuse, Storage and Utilities



### 4.8 Refuse, Storage and Utilities

#### Principle DG21: Consider and allow for servicing, refuse collection and deliveries

The layout of development should be designed and tested to facilitate service vehicles and refuse collections. A continuous connected network of streets helps avoid the need for large turning areas for servicing vehicles.

Consideration must be given to the storage and collection of bins at individual and communal properties. This should normally be attractively integrated into the streetscape and allow for bins to be easily moved to collection points and vehicles. If not properly planned for refuse collection and storage can have a significant detrimental impact on the quality of the streetscape.



Bin store is located within parking spaces and appears to be an afterthought



Bin store obscures building frontage and presents a poor outlook from properties



The bin stores serving this East Grinstead block of flats are discretely integrated within the envelope of the building and around the rear courtyard where they avoid deadening the street frontage. They are also well positioned for ease of collection while providing sufficient separation from the adjacent flats to avoid causing undue nuisance



A bin store discreetly accommodated within the façade

## 4 Site Layout, Streets and Spaces

### Refuse, Storage and Utilities

REFERENCES  
Principle DG24: Plan for cyclists  
MSDC Waste Storage and Collection Guidance for New Developments

#### Principle DG22: Integrate refuse and recycling into the design of new development

Facilities for refuse and recycling storage should be:

- A suitable size to accommodate all the refuse and recycling containers to meet the needs of residents and be of a size acceptable to the refuse collection service;
- Carefully designed and located so they are neither visually obtrusive nor obstruct the passive surveillance of the street, and avoid having a deadening impact on the façade or threshold;
- Located where they will not be obstructed by car parking;
- Within secure and well-ventilated areas;
- Located so that they may be easily accessed from properties but where they will not cause nuisance through unpleasant odours or noise; and
- Coordinated with cycle storage (refer to Principle DG24).

Applicants should refer to the [MSDC Waste Storage and Collection Guidance for New Developments](#).

#### Principle DG23: Integrate sub-stations, utilities and pump stations into the design

Enclosures for utility services including sub-stations and pump stations should be carefully designed and integrated into development so that they do not detract from the quality of streets and public spaces. Consideration of their location must therefore take place early in the design process.

Utility runs should normally run under the footway or carriageway and the location should be carefully planned so that it does not impact on the potential for planting street trees.



Refuse areas should be considered as part of the design of the buildings. If refuse areas are located to the front of the building they should be designed as an integral part of the elevation



A carefully integrated sub-station accommodated at the entrance to a rear parking court which it helps to screen



Pumping stations should be discreetly located where they don't impact negatively on the quality of the environment



Locating sub-stations within areas of open space will not be acceptable

# 4 Site Layout, Streets and Spaces Plan for Cyclists

REFERENCES  
Development Infrastructure and Contributions SPD  
West Sussex Cycling Design Guide

## Principle DG24: Plan for cyclists

To help cycling to become an attractive alternative to the car, bicycles must be conveniently and securely stored. Cycle parking should be planned for in accordance with the Council's standards in its **Development Infrastructure and Contributions SPD**.

In houses, cycle parking should normally be accommodated within the rear garden, car port, garage or outbuilding.

For apartments, cycle storage should normally be provided within the main buildings, preferably close to main entrances as they typically offer more convenience and security than external stores. However, as cycle storage can have a deadening impact upon the façade and threshold, they will need to be carefully integrated to enable an active frontage. Dedicated visitor cycle parking should also be provided for apartments close to main entrances and well overlooked by habitable rooms.

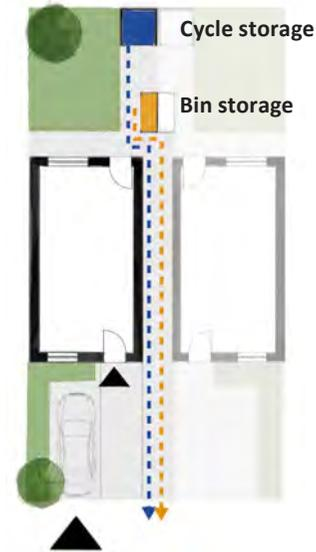

Figure 4Q: Accommodating refuse and cycle storage in rear garden for semi-detached house

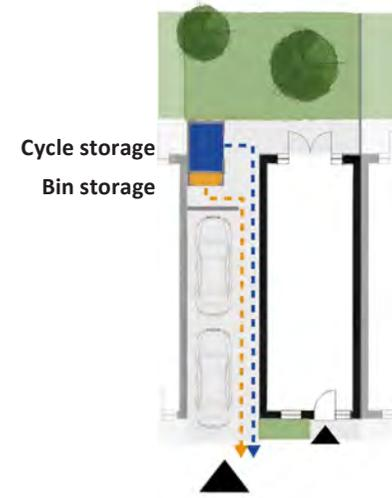

Figure 4R: Accommodating refuse and cycle storage to rear of car port

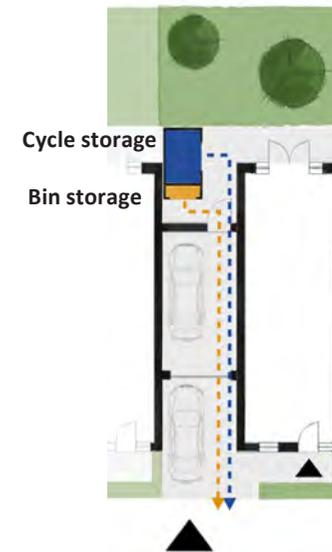

Figure 4S: Accommodating refuse and cycle storage to rear of garage

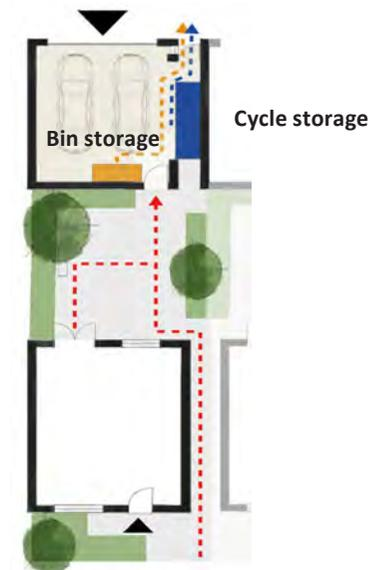

Figure 4T: Accommodating refuse and cycle storage in garage accessed from rear shared court

# 4 Site Layout, Streets and Spaces

## Open Space and Public Realm

### 4.9 Open Space and Public Realm

#### Principle DG25: Enhance the environment and sense of place through open spaces

Open spaces make an important contribution to the character of an area and encourage healthy lifestyles by providing both physical and visual amenity and a focus for social, play and sporting activities and events.

Open space should be provided as an integral part of a development and designed with a specific role or function as part of the wider open space network (refer also to DG4). They should take the opportunity to create environments and facilities that provide for and encourage inclusive activity for all age groups and abilities.

Open spaces should be designed according to the following principles:

- To optimise their recreational potential by providing multi-functional all year-round activity including both hard and soft surfaced areas;
- To be safe places defined by building frontages providing appropriate enclosure and overlooking;
- To positively respond to potential desire lines that cross the space (including public rights of way); and
- To consider the future maintenance of open spaces when designing proposals with provision made for the ongoing costs. Outdoor furniture and equipment should be attractive, robust, durable and coordinated.

On larger developments (300+ dwellings) consideration should also be given to setting aside land for productive use by residents such as allotments.

Applicants should refer to the **Mid Sussex District Council Development Infrastructure and Contributions SPD**.

REFERENCES  
MSDC's Development Infrastructure and Contributions SPD  
Sport England & Public Health England Active Design Principles



A large open space with a range of formal and informal activities that form the central focus of the Wychwood Park development in Lindfield

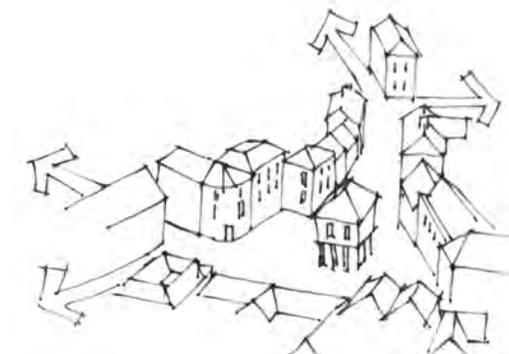

Figure 4U: Informal space and buildings



Figure 4V: Formal space with semi-formal building

# 4 Site Layout, Streets and Spaces

## Open Space and Public Realm

### Principle DG26: Integrate space for play into the design

Playing is important to children's well-being. It helps to develop their physical abilities and their emotional responses. Where play is collaborative, it can help to improve children's interpersonal skills. Where play involves exploration and creativity, it can help children think in a flexible manner and develop learning and problem-solving skills.

Children's play areas and equipment should normally be provided as part of new residential developments of 50 dwellings and above and on smaller developments when there are no existing nearby facilities. Play spaces provide an important community focus particularly where there is an absence of other community facilities; they should not be marginalised to the edge of developments but provided centrally in an accessible location where they are overlooked by surrounding properties.

Play spaces should provide a range of equipment suitable for the intended age group and integrated with natural landscape to enable contact with nature.

On larger developments, where there are other facilities, play areas and open space should be located close to neighbourhood centres to create a critical mass of activity and help to sustain the facilities.

Applicants should refer to the following national and local guidance:

- **Design for Play: A guide to creating successful play spaces** (Play England, August 2008);
- **Public Space Lessons: Designing and planning for play** (CABE, October 2008); and
- MSDC's Draft Play and Amenity Green Space Study and Draft Play Space and Youth Facilities Design Guidance.

### REFERENCES

**Design for Play: A guide to creating successful play spaces** (Play England, August 2008)

**Public Space Lessons: Designing and planning for play** (CABE, October 2008)

MSDC's Draft Play and Amenity Green Space Study and Draft Play Space and Youth Facilities Design Guidance



Local playspace well overlooked by adjacent development



Play spaces should not be sited to the rear or side of buildings where overlooking is limited. This can often lead to anti-social behaviour



Play spaces should be integrated within the overall landscape design and include elements of natural play and learning environments

## 4 Site Layout, Streets and Spaces

### Open Space and Public Realm

#### Principle DG27: Integrate tree planting and soft landscape

Trees and soft landscape make an important contribution to the character of an area by providing both physical and visual amenity, improving biodiversity and enhancing sense of place. They have a strong impact on people's well-being, soften the impact of buildings and structures, and indicate the passage of the seasons through their growth and change through the year, and should therefore be incorporated throughout new development.

From the outset, there should be a clear landscape strategy that is an integral part of the design of new development covering all streets and public spaces while accounting for the growing process. Consideration must also be given to the future maintenance of trees and plants in the design. Native trees and shrubs and longer-lived species should be selected where possible and appropriate as they support a greater variety of wildlife, are often more suited to local conditions and better reflect the character of the wider countryside.

Trees and soft landscaping should be selected and located according to:

- The growing space available;
- Its final height, spread and form at maturity;
- The soil type and volume;
- The existing species in the locality;
- The intended character of an area, street or public space (for example, formal sculptural planting or softer informal planting);
- The location of existing underground or overhead services;
- Proximity to roads, ensuring sight lines and forward visibility is maintained;
- Proximity to buildings ensuring that overlooking of the street and spaces is maintained and overshadowing minimised;
- The location of highway lighting;
- The scale and importance of a street with larger stature trees on main streets and smaller species selected for minor routes (that helps the legibility of layouts); and
- The need for more formality/informality and street enclosure with more formalised tree planting, and tree species normally sought on main streets and spaces to reinforce their importance in the street hierarchy.

Creating avenues of a single species normally helps to deliver the necessary formality for main streets and spaces, applicants should nevertheless avoid over-long stretches of the same species to safeguard against the risk of tree losses through disease; changing species block by block is therefore recommended.

All street trees should normally have a regular shape and form.



Generous tree and shrub planting can significantly enhance the quality of the public realm / streetscape

# 4 Site Layout, Streets and Spaces

## Open Space and Public Realm

### Principle DG28: Recommended tree species

The following tree species are suggested although it is recognised this is not an exhaustive list and other species and cultivars will be considered:

#### Main streets - native (preferred)

- *Alnus glutinosa* or *Alnus cordata*;
- *Quercus palustris* (pin oak).
- *Quercus robur* (oak);
- *Tilia cordata* 'Streetwise' or 'Greenspire' (small leaved lime); and
- *Ulmus* 'New Horizon' (elm).

#### Main streets - alternative options (occasionally appropriate)

- *Acer platanoides* 'Emerald Queen' (Norway maple); and
- *Ginkgo biloba* (Maidenhair tree).

#### Secondary Streets

- *Acer campestre* (field maple);
- *Corylus colurna* (Turkish hazel);
- *Coryllus avellana* (hazel);
- *Liquidamber styraciflua* (sweet gum tree).
- *Sorbus aria* (whitebeam); and
- *Sorbus aucuparia* (rowan).

#### Minor / Tertiary Streets

- *Arbutus unedo* (strawberry tree);
- *Crataegus x lavalleyi*;
- *Crataegus* species (hawthorn);
- *Ligustrum lucidum*;
- *Malus* 'Evereste' (crab apple); and
- *Sorbus aucuparia* (rowan).

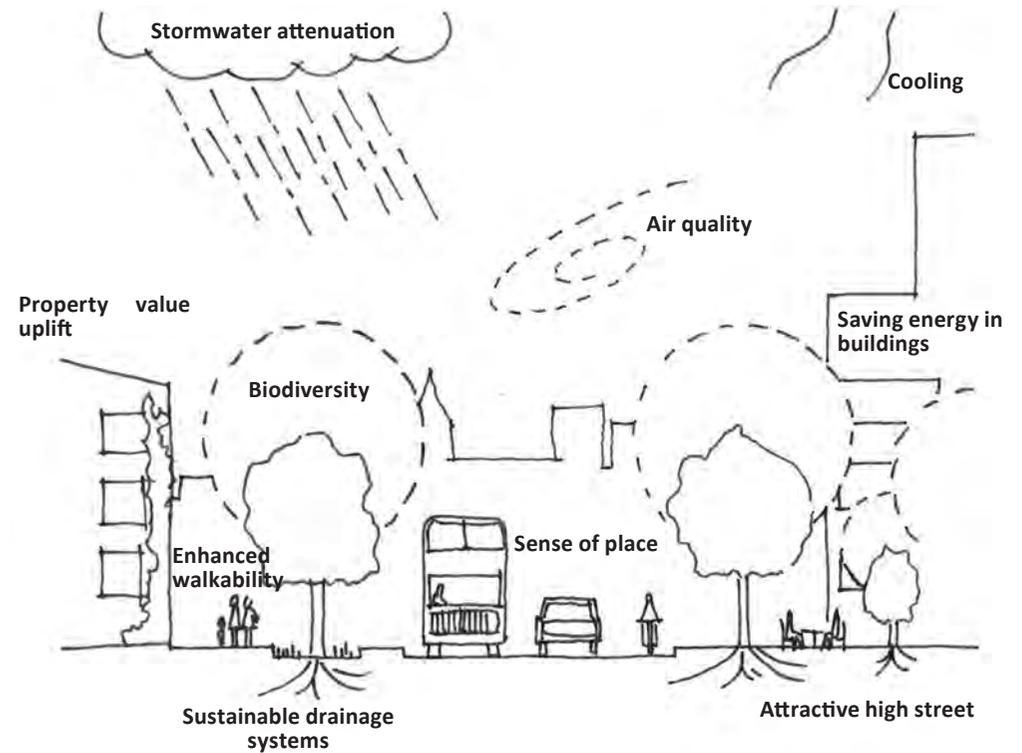

Figure 4W: The benefits of tree planting and soft landscaping



A regular line of trees planted along a main axis in Bolnore Village



Figure 4X: Professionally designed tree pits should be used to provide the necessary soil volume required to successfully establish the tree. Tree pit design needs to consider any adjacent service runs and particular care is needed for trees in hard surfaces

## 4 Site Layout, Streets and Spaces

### Open Space and Public Realm

#### Principle DG29: Deliver a coordinated public realm with high quality landscape

Applicants should ensure that the public realm is designed in a coordinated manner using a consistent palette of high quality and robust materials in combination with appropriate soft landscaping and avoiding cluttering the street with excessive furniture or signage.

Surface materials and street furniture should be informed by their appearance in relation to the existing character of an area, their intended purpose, and the maintenance, management and technical requirements. This should help to create a coherent environment and sense of place that can stand the test of time.

#### Surface Materials

Natural stone either as flags, setts or cobbles or brick may be the most appropriate, especially in historic and rural locations. Concrete or tarmac should normally be coordinated with other surface materials as well as soft landscaping as otherwise their uniform appearance and sharp finish can undermine the character of a new development.

#### Street Furniture

Street furniture should be simple, high quality, robust and responsive to its setting and integral to the landscape design. It should be restricted to essential items and functions and combined where possible. For example, attaching signs to lamp posts, mounting streets signs and/or lighting on buildings.

#### Lighting

Light fittings should be low energy and be designed to avoid causing light pollution particularly in sensitive and dark sky rural areas.

#### Utilities

Applicants should consider utility requirements such as supply boxes, cable runs and maintenance access and the location of electric vehicle charging points at an early stage of the design process to avoid conflicts between these and landscape features, tree planting and public realm designs.

#### Public Art

On larger schemes there is often an opportunity to incorporate public art in the proposals. This should be considered at an early stage in the design process and carefully integrated to ensure it is well related to the development proposals.



Imberhorne Lane, East Grinstead - high quality materials distinguish the shared surface areas



Public art can be used as an integrated feature within the streetscene

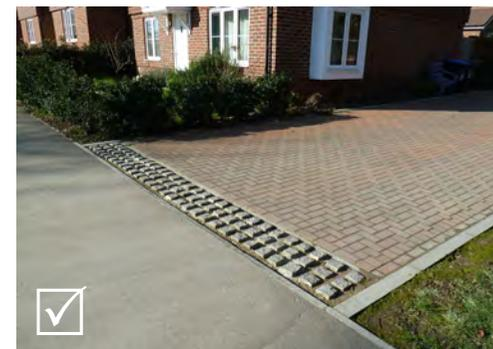

A granite sett rumble strip marks the junction between secondary and minor streets

## 4 Site Layout, Streets and Spaces Open Space and Public Realm

### Principle DG30: Design for everyone and look to the future

The public realm should be designed so that it:

- Reflects the diversity of people using spaces;
- Is convenient, safe and easy to use for all people without having to experience undue effort, barriers to access or separation;
- Enables everyone to participate equally, confidently and independently in everyday activities irrespective of a person's mobility, age, gender or ethnicity;
- Meets the needs of wheelchair users, mobility impaired people and people with pushchairs;
- Encourages social interaction and does not purposely design-out the activities of young people or other groups; and
- Provides sensory richness.

In particular applicants should:

- Ensure that street furniture, signage, lighting and visual and textural contrast in the paving materials are carefully designed and reflect the needs of all potential users; and
- Provide sufficient levels of accessibility for all potential users in terms of accessible parking, pavement space and access to public transport.



The central square in Kings Weald, Burgess Hill to be defined on all sides by public facilities including a shop, community centre and health centre



Regularly planted lines of London Plane trees significantly enhance Bolnore Village's main square

# 4 Site Layout, Streets and Spaces

## CHECKLIST (Part One)

### How to use

This table provides a checklist for use by both the applicant and planning officer to check that appropriate consideration has been given to how an application has addressed the **site layout, streets and spaces**.

**PROCESS:** Have you read, understood and applied the principles set out above?

**PROCESS:** The adjacent table summarises the key principles set out within this section and can be used by applicant and officer as a checklist.

The applicant is expected to meet the requirements of all relevant Principles (ie a tick in each box) or provide a justification for failure to do so.

PRINCIPLE	DESCRIPTION	CHECK
<b>DG12: Connected Street Network</b>	Does the design provide a clear street hierarchy and network of open spaces?	
	Does the design create a grid network of streets and perimeter blocks?	
	Do development blocks take account of natural features orientation and topography?	
<b>DG13: Frontage</b>	Does the design provide enclosure of street space and continuous frontages with corners of blocks appropriately emphasised?	
<b>DG14: Enclosure</b>	Does the proposal provide an appropriate sense of enclosure appropriate to the street hierarchy and achieve a human scale?	
<b>DG15: Legibility, and Street Hierarchy</b>	Does the structure or layout of the proposed development appear easy to navigate and easy to understand?	
	Has the applicant demonstrated how the use of landmarks, marker buildings and vistas has informed the proposal?	
<b>DG16: The Development Edge</b>	Has the applicant (where applicable) demonstrated how their proposals provides a positive edge with building frontages facing site boundaries served by roads that run adjacent to the site edge?	
	Has the applicant (where applicable) demonstrated a sensitive response to the rural edge? This will normally require less density and additional soft landscaping along the boundary.	
<b>DG17: Pedestrian Friendly Streets</b>	Are the proposals designed as social spaces with the needs of pedestrians, cyclists and public transport users put above the needs of the motorist?	
	Is the street environment designed to encourage pedestrian movement through appropriate pavement widths, avoiding unnecessary barriers or clutter and providing places for pedestrians to rest, gather and socialise.	
	Are traffic calming measures integrated within the design of the streets?	
<b>DG18 - 20: Car Parking</b>	Is parking for both residents and visitors proposed at an adequate level in response to the location of the site and in locations that safeguard the quality of the street environment?	
	Is the parking provision in line with West Sussex County Council Parking standards?	
	Have car club spaces and electric charging points been incorporated into the proposals? (larger sites only)	
<b>DG21-23: Refuse, Storage and Utilities</b>	Has the layout of development been designed to facilitate service vehicles and refuse collections?	
	Are sub-stations and pump stations carefully designed and integrated into development so that they do not detract from the quality of streets and public spaces?	
	Are utility runs located where they do not impact on the potential for street tree planting?	
	Are refuse and recycling facilities conveniently located and unobtrusive	

## 4 Site Layout, Streets and Spaces

### CHECKLIST (Part Two)

PRINCIPLE	DESCRIPTION	CHECK
<b>DG24: Plan for Cyclists</b>	Does the design provide adequate cycle parking in suitable locations for both public and private users?	
	Does the design include for secure and convenient storage of bicycles in residential dwellings?	
<b>DG25: Open Space</b>	Does the design link existing and proposed landscapes and open spaces to form open space networks and contribute and respond to the hierarchy of existing open spaces?	
	Are all spaces designed with a specific role or function to avoid residual, unused or neglected spaces?	
	Do the proposals provide the appropriate level of open space in accordance with MSDC Infrastructure and Contributions SPD?	
<b>DG26: Play Space</b>	Where applicable has the design provided the appropriate level of playspace in accordance with the MSDC Infrastructure and Contributions SPD?	
	Is the design for playspaces in line with guidance on inclusive play, including Design for Play: A guide to creating successful play spaces (Play England, August 2008)?	
<b>DG27 - 28: Trees and Soft Landscape</b>	Has tree planting and soft landscaping been provided within street designs? Are tree species appropriate for their location and to the nature and hierarchy of the street.	
	Has the applicant demonstrated that the species selected are appropriate for the location?	
	Has the applicant demonstrated that the long-term maintenance and management of landscape elements have been considered to ensure their successful establishment?	
<b>DG29: Public Realm</b>	Has a suitable palette of high quality materials been proposed that responds to the character of the place as identified in the Character Study?	
	Has the selection of street furniture been restricted to essential items and have functions been combined where possible?	
	Is the street furniture simple, high quality, well designed, robust and responsive to its setting?	
	Has a lighting strategy been proposed that: minimises the impact of lighting columns on the streets; accords with the design approach to other street furniture and avoids causing light pollution particularly in sensitive and dark rural areas?	
	Has the location, design and integration of utilities within the landscape been considered to mitigate their impact on the public realm?	
	Has the provision of public art been considered?	
<b>DG30: Inclusive Design</b>	Has the applicant demonstrated that the principles of inclusive design have been considered and incorporated within the design from the outset?	



# 5 Site Optimisation and Mixed-Use Layouts



## 5 Site Optimisation and Mixed Use Increased Density



### 5.1 Planning for Increased Density

5.1.1 Increasing the intensity of development in the most accessible locations will help to deliver much needed homes and employment space in the most sustainable places reducing both the need to travel and the pressure to build on the countryside.

5.1.2 This chapter identifies the opportunity for intensification across the District and the form and mix of uses that it may take.

5.1.3 The towns form the centres of activity within the District and are the focus for shops, community and employment uses. These centres offer the potential for intensification to provide much needed homes and jobs in the most accessible and sustainable locations.

5.1.4 New homes and footfall in central locations can help to support additional community facilities and bring additional life to the District's centres. It also helps reduce the outward spread of settlements safeguarding agricultural land while preserving unspoilt landscapes and natural habitats.

5.1.5 Larger urban extensions also offer the potential for higher densities particularly around neighbourhood centres.

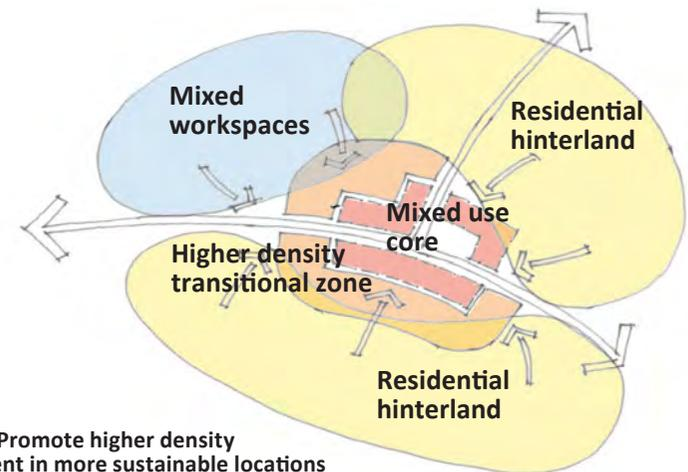

Figure 5A: Promote higher density development in more sustainable locations

#### Principle DG31: Focus development in sustainable locations

New development should generally respond to the scale, massing and grain of adjacent areas and the settlement context within which it is located. However, in some parts of the District there may be an opportunity to deliver a new development character provided this is part of a comprehensive vision, establishes sense of place and does not impact on the sensitive townscape or landscape assets of an area. This will also be restricted to areas where there is good accessibility to shops and services or good public transport links that minimise the need to travel and/or reliance on private vehicles.

There are opportunities to promote a greater concentration of development in:

- The District's three town centre locations within areas identified as being coarse grain (refer to Section 2.5);
- Sites close to town centres that have been identified in MSDC's Brownfield Register as having the capacity to accommodate additional scale of development;
- The most accessible parts of new urban extensions where this does not adversely impact on existing homes/ character and the rural edge; and
- Employment sites (refer to chapter 7).

Higher density schemes should promote green travel options including reduced parking provision, provision of car club spaces and improved public transport.

# 5 Site Optimisation and Mixed Use Intensification in Town Centres

## 5.2 Town Centre Intensification

### Principle DG32: Managing increased density in town centres

Development density should be appropriate to the location and respond to and/or enhance the character of the existing settlement.

The District's towns are largely composed of low-rise development, typically of two and three storey buildings and have the greatest potential to deliver increased density. The opportunities exist for more intensive development within the part of the town centres identified as coarse grained in Figures 5B, 5C and 5D because of their inconsistent built form or fragmented street layout (refer to sections 2.5 and 2.6). Increased height and massing within the town centre intensification areas must be carefully managed as part of a coherent and comprehensive vision which establishes a more urban form composed of street blocks and spaces with typical building heights of four to six storeys (four to five in East Grinstead). Development that exceeds this height risks being unduly prominent and/or out of scale with the surrounding streets and buildings.

Any development that promotes a scale, height and massing that is greater than the existing context must also demonstrate that it does not:

- Cause significant harm to the amenity of adjacent properties (refer to chapter 8);
- Adversely impact on views of the wider townscape and landscape;
- Adversely impact on the quality of the streets and spaces; and / or
- Generate parking that dominates or adversely impacts on the public realm.



An office development in Haywards Heath town centre that has optimised its site by accommodating parking at semi-basement level



A recent higher density residential scheme in Haywards Heath town centre that has been carefully designed so that it does not overwhelm nearby buildings



New residential development replacing employment uses on Victoria Road, Burgess Hill, establishes a consistent scale and massing and building line



A recent higher density scheme in East Grinstead town centre which has reduced its apparent scale by employing consistent vertical articulation

## 5 Site Optimisation and Mixed Use Intensification in Town Centres

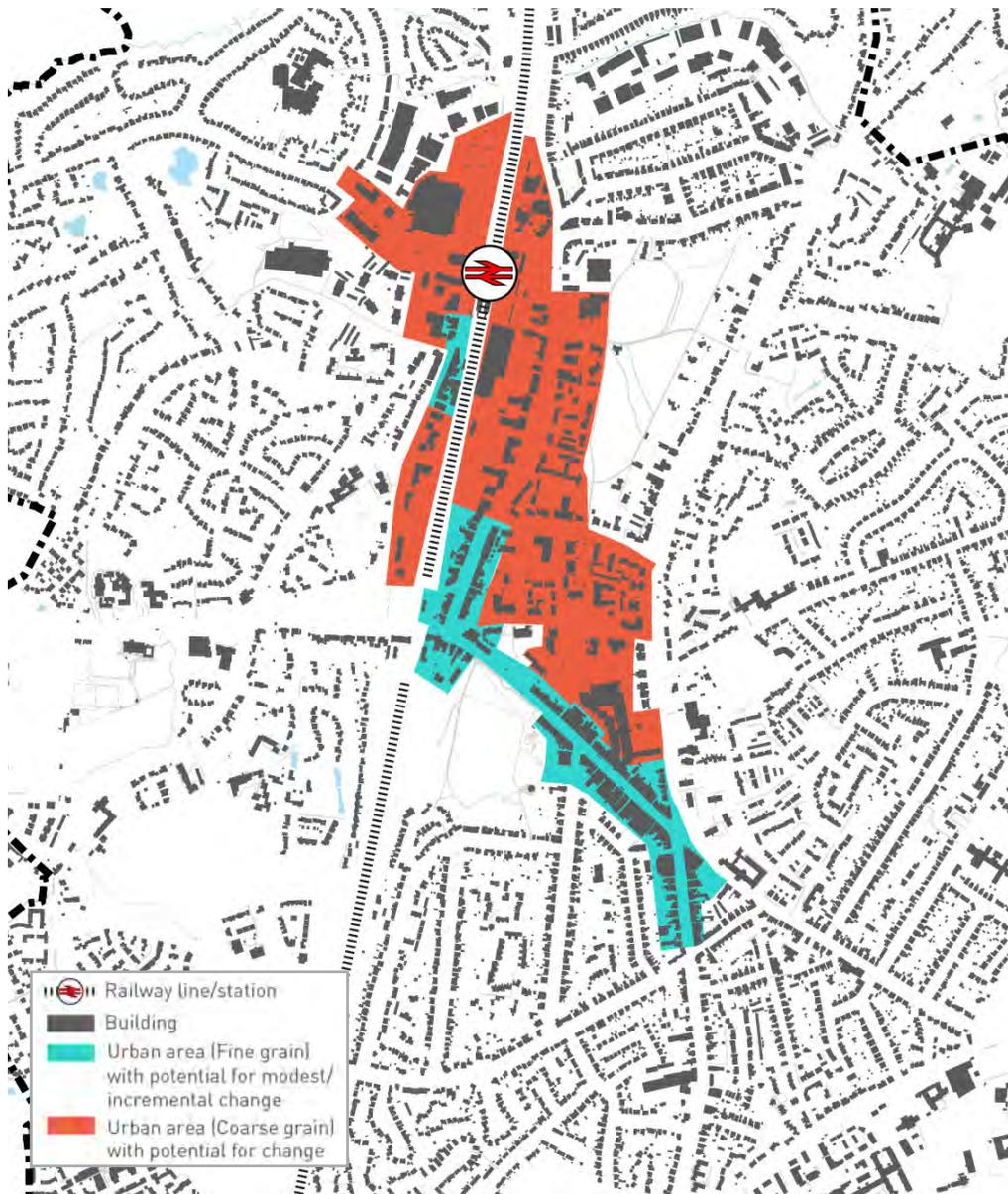

Figure 5B: Haywards Heath - opportunities



Figure 5C: Burgess Hill - opportunities



Figure 5D: East Grinstead - opportunities

## 5 Site Optimisation and Mixed Use Best Practice Case Study

### Case Study Three: Town Centre Intensification - Walthamstow High Street

#### *Delivering compact higher density development*

##### **Overview**

This scheme has similarities with Mid Sussex towns as it introduces intensification within the context of a two and three storey residential area.

It delivers a compact mixed-use urban scheme that has brought new life and activity to the area. The scheme includes a multiplex cinema, restaurants and shops at ground floor level with apartments above within blocks of five and six storeys.

Buildings appropriately define existing streets and have been carefully articulated so they do not overwhelm the existing townscape. The scheme is mixed tenure with residents having access to a courtyard space in the heart of the scheme.

The street environment on the high street has been transformed and cafes and restaurants spill out across a high quality public realm that benefits from a simple coordinated design and mature trees.

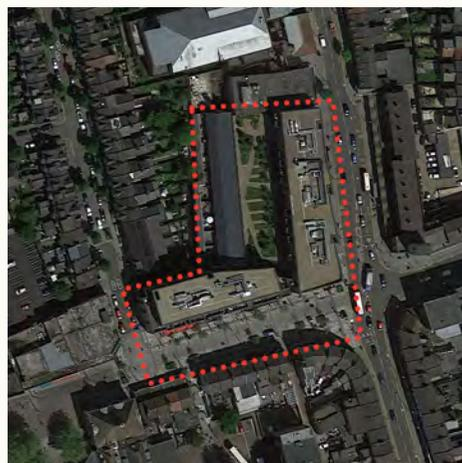

**Architect:** Pollard Thomas Edwards

**Site area:** 0.67 Hectares

**Number of Homes:** 121

**Density:** 180 homes per hectare

# 5 Site Optimisation and Mixed Use Tall Buildings

## Principle DG33: Potential for tall buildings (over 6 storeys)

High density development can normally be delivered through well designed compact development without the need for tall buildings.

In exceptional circumstances there may be potential for tall buildings (above six storeys) in the town centres, where it can be demonstrated that they play a role in improving legibility, for instance marking the location of the railway station or a civic space and contribute to the overall town centre regeneration.

Any tall building will need to be:

- A height and scale, mass and volume that is proportionate to its role, and its position in the local context; and
- An outstanding and elegant design that makes a positive contribution to the skyline when viewed from any direction.

Tall buildings should also:

- Enhance the character and distinctiveness of an area without adversely affecting established valued townscapes and views including Conservation Areas and Listed Buildings and their settings;
- Present a positive relationship with the street and deliver a high-quality public realm; and
- Be designed to avoid creating any adverse impact on the microclimate and amenity of the proposal site and the surrounding area.

The relationship of a tall building with the public realm is important and tall buildings should be promoted as part of a comprehensive proposal that can address the challenges of servicing and provision of a mix of uses to provide activity at the ground floor level.



Stockwell Court, Haywards Heath - one of the few tall buildings in the District - poorly designed at right angles to the street and inappropriately tall in relation to its context



Tall buildings should be delivered as part of a comprehensive scheme

## 5 Site Optimisation and Mixed Use

### Optimising Urban Extensions



#### 5.3 Optimising the Development Potential of Urban Extensions

##### Principle DG34: Managing increased density in urban extensions

The character and form of the different parts of urban extensions should vary in order to enhance the overall legibility and distinctiveness of the development while also delivering a balanced community. A range of densities, building types and forms will normally be required with higher density development in the more accessible locations and lower density development in the peripheral areas. Grouping housing types further aids diversity across a development.

More compact development that creates a stronger sense of street enclosure should normally be promoted along main streets and around neighbourhood centres where it also helps to reinforce the importance of these areas. This can be delivered through a combination of greater height, vertically articulated frontages and terracing of properties to deliver a more continuous street frontage with underlying rhythm and order.

Promoting higher buildings fronting onto public spaces is often appropriate as they provide more overlooking and increase the sense of enclosure.

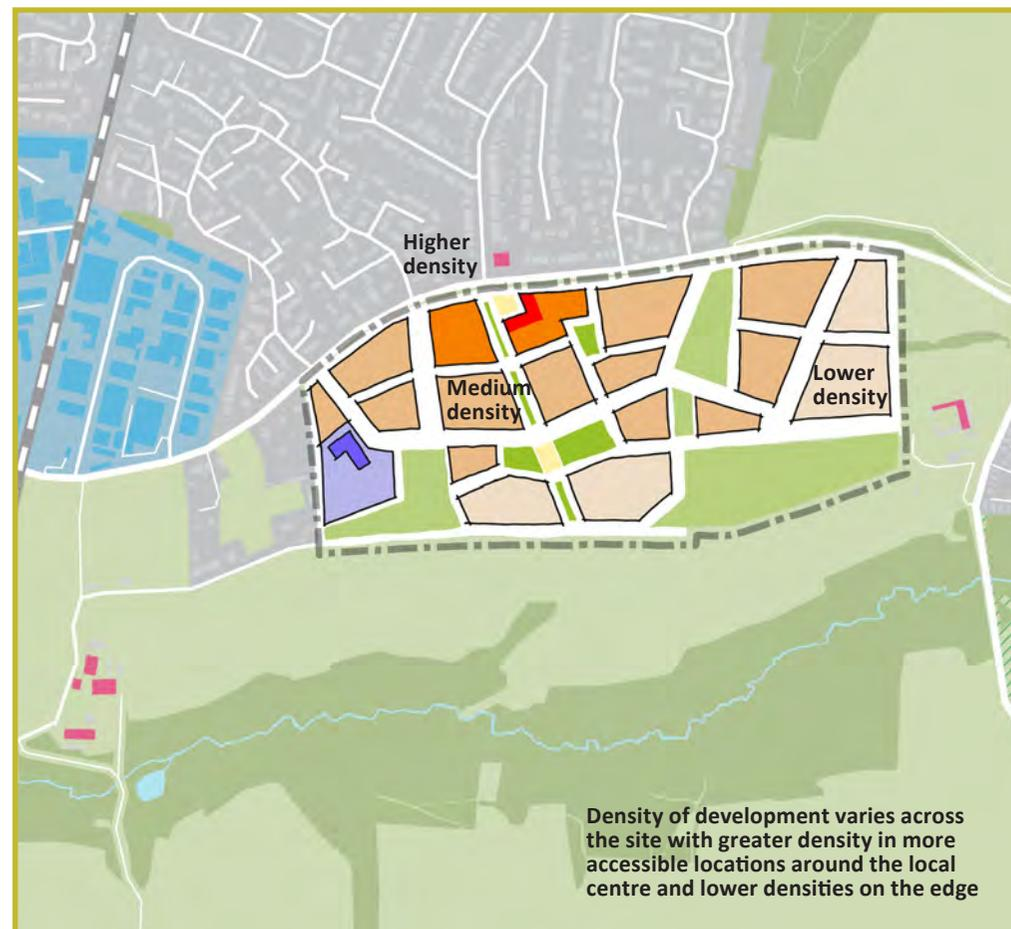

Figure 5E: INDICATIVE SITE CONCEPT PLAN 9 Increasing density in relation to accessibility

# 5 Site Optimisation and Mixed Use Best Practice Case Study

## Case Study Four: Compact urban extension - Upton, Northampton

### *Delivering a compact urban extension*

#### **Overview**

This greenfield urban extension delivers new homes at a relatively high density that supports a local centre and school. It provides a strong identity through a perimeter block arrangement that incorporate a framework of open spaces.

The main streets and spaces are defined by higher building frontages of 3 and 4 storeys with the secondary streets featuring 2 and 3 storey frontages. Continuous street frontages, that further strengthen the street enclosure is helped by incorporating most of the car parking within rear courtyards where it is less conspicuous. This arrangement also allows SuDs in the form of swales to be incorporated as an attractive feature that characterise the main streets. The development was delivered in several phases incorporating traditional-looking buildings in the early phases and adopting a more contemporary architectural language in later phases.

**Architect:** various following EDAW masterplan

**Site area:** 43 Hectares

**Number of Homes:** 1,350

**Density:** 31.4 homes per hectare overall (including open spaces); net densities 50-60 dph



## 5 Site Optimisation and Mixed Use

### Mix of Uses



#### 5.4 Mix of Uses

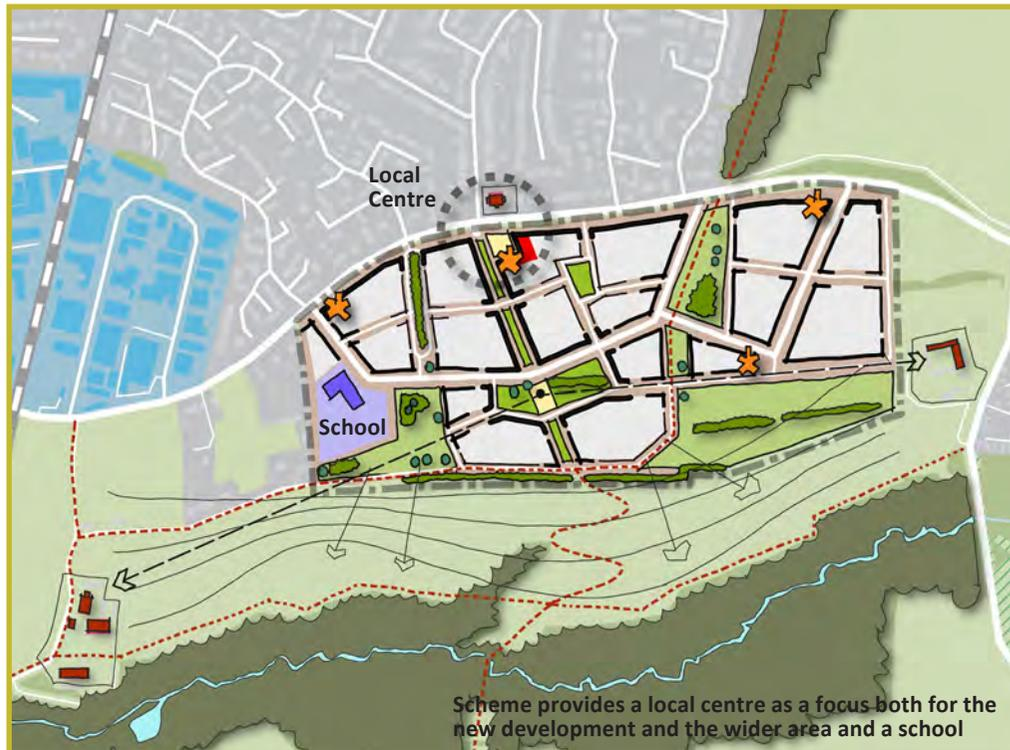

Figure 5F: INDICATIVE SITE CONCEPT PLAN 10 - Provide a mix of uses

#### Principle DG35: Promote a mix of uses within larger schemes to provide services to meet local needs, conveniently located where they are most accessible

Mixed-use schemes are promoted because they positively contribute to sustainability by providing local facilities within walking distance and give developments a community focus.

Larger proposals (300+) should normally include local services and facilities in addition to public space. The extent of the provision will nevertheless depend on economic viability, the existing local provision and potential catchment area.

The location of mixed-use centres and neighbourhood hubs within a development is key to their viability and long-term success. They should normally be:

- Conveniently located preferably at the intersection of well-connected streets;
- A walkable and cyclable distance from the surrounding residential development;
- Highly visible;
- Accessible for all users; and
- Served by a bus route.

They should normally be designed:

- As a cluster of facilities around an appropriately scaled high quality public space that provides a central focus between building frontages that define the space;
- With residential development above non-residential uses to enable activity and surveillance throughout the day and night;
- With the non-active parts of larger non-residential buildings (such as supermarkets or leisure buildings) concealed within blocks enabling an active frontage around the perimeter;
- With servicing areas located where they do not visually dominate the streetscene and avoid dead frontage overlooking the public realm; and
- With short stay / visitor and disabled car parking spaces and secure cycle parking discreetly integrated into the streetscape and landscape design.

# 5 Site Optimisation and Mixed Use

## Mix of Uses

### Principle DG36: Create mixed communities and housing that is adaptable to change

Development that is capable of responding to changing social, technological and economic conditions is more likely to be successful and ultimately more sustainable.

Particularly on larger sites, new housing should reflect people's differing requirements and desire to adapt or change their property to respond to changing needs. New residential development should provide a mix of dwelling types (including apartments and terraced homes) and tenures to meet local need as identified in District Plan Policies DP30: Housing Mix and DP31: Affordable Housing.

Affordable housing should be 'pepper-potted' throughout the site and have the same external appearance and quality of finishes as private housing. There are nevertheless architectural benefits of grouping identical housing types as it gives street frontages underlying rhythm and order; it can also aid diversity across the development.

Buildings should be designed so that they can be altered internally or externally over time without the need for demolition or rebuilding as needs change. By building flexible internal space, rooms can be adapted to different uses depending on family requirements.

Buildings should be designed to maximise the potential for lifetime use (refer to Lifetime homes guidance for further details). New residential developments should address the needs and access requirements of people with disabilities and include the provision of wheelchair accessible homes. These homes should be positioned in highly accessible locations.

#### REFERENCES

District Plan Policy DP30: Housing mix  
District Plan Policy DP31: Affordable housing  
MSDC Affordable Housing SPD  
The Lifetime Homes Standard



Wilmington Way, Haywards Heath includes a mix of apartments and house typologies that are grouped into frontages to give an underlying rhythm and order



The sales office for the original Bolnore Village development has been adapted to become a children's nursery

# 5 Site Optimisation and Mixed Use CHECKLIST

## How to use

This table provides a checklist for use by both the applicant and planning officer to check that appropriate consideration has been given to how an application has addressed issues around **site optimisation and mixed use** layouts.

**PROCESS:** Have you read, understood and applied the principles set out above?

**PROCESS:** The adjacent table summarises the key principles set out within this section and can be used by applicant and officer as a checklist.

The applicant is expected to meet the requirements of all relevant Principles (ie a tick in each box) or provide a justification for failure to do so.

PRINCIPLE	DESCRIPTION	CHECK
<b>DG31-32: Increased Density</b>	Has the applicant demonstrated that their site is located in an appropriate location in which to promote development of a scale, height and massing that is greater than the prevailing context?	
	Has the applicant demonstrated that their proposals do not cause unacceptable impacts on adjacent properties in respect of daylighting, sunlighting and overlooking?	
	Has the applicant demonstrated that their proposals do not adversely impact on views of the wider townscape?	
<b>DG33: Tall Buildings</b>	Where a tall building is promoted is the height proportionate to the buildings role, and the importance of the location in the local context?	
	Where a tall building is promoted is it of outstanding design quality and does it make a positive contribution to the skyline when viewed from any direction?	
	Where a tall building is promoted does it enhance the character and distinctiveness of an area without adversely affecting established valued townscapes and views?	
	Where a tall building is promoted does it present a positive relationship with the street and deliver a high quality public realm?	
	Where a tall building is promoted has it been demonstrated that it does not adversely impact on the microclimate and amenity of the proposal site and the surrounding area?	
<b>DG34: Increased density in Urban Extensions</b>	Does the urban extension promote development at a range of densities in order to aid legibility and to increase distinctiveness?	
	Is development taller and / or more compact along main streets to increase the sense of enclosure?	
<b>DG35: Mix of Uses</b>	Does the proposal provide a mix of uses conveniently located to meet local needs? (where appropriate)	
	Are these uses located where they are easily accessible and visible to attract custom?	
	Are servicing areas designed so that they do not visually dominate the streetscene?	
	Is adequate cycle and car parking provided and in a convenient location?	
<b>DG36: Mixed Community</b>	Does the proposal provide a mix of residential dwelling types and tenures to meet local need?	
	Are affordable homes 'pepper-potted' throughout the site, and have the same external appearance and quality of finishes as private housing?	
	Are buildings designed so that they can be altered internally or externally over time without the need for demolition or rebuilding as needs change?	



# 6 High Quality and Sustainable Building Design



# 6 High Quality Building Design Sustainable Buildings

## 6.1 Introduction

6.1.1 This chapter outlines the important principles to consider in designing new buildings. Key to this is adopting a design approach that minimises their environmental impact. The various components of new buildings including their form, proportions, roofscape and overall appearance should also display underlying architectural integrity and contribute to a sense of place by being borne from their location. Being responsive to the character of the existing built form should not result in pastiche replicas, instead the emphasis should be placed on contemporary interpretation of traditional building forms to suit today's needs.

## 6.2 Sustainable Buildings

### Principle DG37: Deliver high quality buildings that minimise their environmental impact

The construction industry makes a significant contribution to CO2 emissions utilising substantial volumes of non-renewable resources and generating pollution and waste. The need for sustainable approaches to building design is therefore fundamental if the challenges associated with climate change, resource depletion and pollution are to be addressed, and will be necessary to achieve the Government's Future Homes Standard.

The Council welcomes innovative and inventive designs that respond to the sustainability agenda by minimising the use of resources and energy both through building construction and after completion.

Applicants must demonstrate how this has informed their design and should consider in particular:

- Orientation and design of buildings and roofs to maximise daylight / sunlight penetration and solar gain, whilst also avoiding overheating;
- The use of green roofs or walls to reduce storm water run-off, increase sound-proofing and biodiversity;

REFERENCES  
District Plan Policy DP39:  
Sustainable design and  
construction

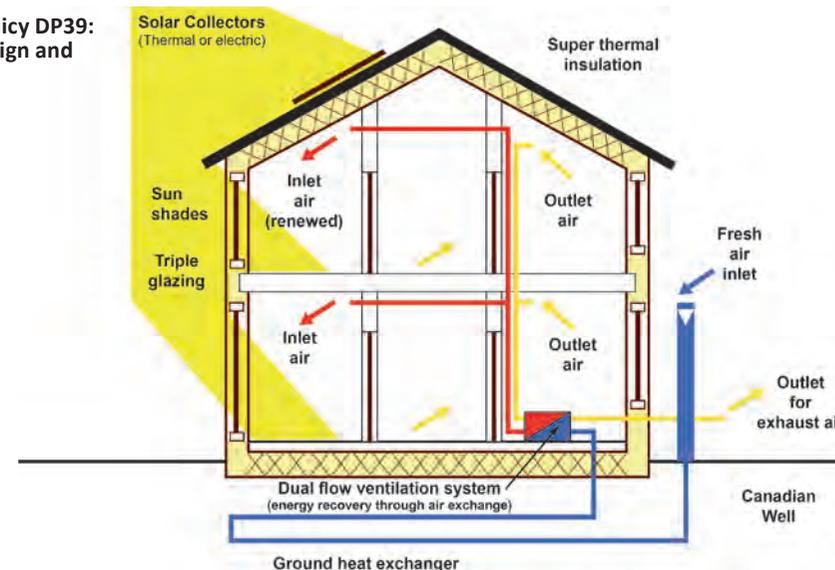

Figure 6A: Sustainable construction principles

- The use of materials with low embodied energy (for example, renewably-sourced timber and recycled materials);
- The use of sustainable materials that are locally sourced wherever possible;
- Incorporating high levels of insulation (in combination with air tightness and temperature control systems) including the use of materials with a high thermal mass, such as stone or brick, which store heat and release it slowly;
- Incorporating renewable energy including photovoltaics, solar thermal water heating, ground and air source heat pumps;
- The use of low flow technology in water fittings, rainwater harvesting systems and grey water recycling systems to reduce water consumption to 110 litres/person/day (maximum); and
- Laying out development to support identified opportunities for decentralised renewable or low carbon energy systems.

Further guidance is provided by District Plan policy DP39: Sustainable Design and Construction

# 6 High Quality Building Design Best Practice Case Study

## Case Study Five: **Wilmington Way, Haywards Heath**

### *Delivering sustainable buildings*

#### **Overview**

The architects for the Wilmington Way scheme considered the sustainability agenda from the outset. The contemporary styled houses that help give the scheme its strong identity have been designed to respond to their orientation with most of them incorporating south-facing roof profiles to maximise solar collection.

This is ingeniously achieved without compromising the street-based layout by designing the north/south facing houses with pitched roofed frontages, and the east/west facing roofs with asymmetric gable frontages.

The scheme replaced an unattractive flat-roofed 1960's estate that was difficult to navigate with a highly legible scheme which features an open space as its centrepiece that provides a natural community focus. This space and the streets are well overlooked and defined by new building frontages, resulting in an attractive and safe public realm.



**Architect:** PRP Architects

**Site area:** 3.58 Hectares

**Number of Homes:** 185

**Density:** 52 homes per hectare

# 6 High Quality Building Design Architectural Integrity

## 6.3 Delivering Architectural Integrity and a Sense of Place

### Principle DG38: Design buildings with architectural integrity and a sense of place

Applicants should establish an architectural approach and identity in the design of building that is borne from the place.

The facade and elevational treatment, roofscape fenestration and materials used in existing buildings within the locality should be a starting point for the consideration of architectural design of new buildings. However, this should not result in pastiche replicas of traditional buildings. Instead a re-interpretation of key aspects of their form should be demonstrated.

Good architecture involves the successful co-ordination of proportions, materials, colour and detail. Buildings should therefore be holistically designed with each part in harmony with its whole while appropriately responding to both its context and modern living requirements. This includes:

- The elevational treatment and overall façade design;
- The placement, proportions and design of windows, doors and balconies;
- A roofscape and form that creates a harmonious composition and minimises the visual impact of downpipes and guttering;
- The appropriate incorporation of dormer windows and chimneys;
- An appropriate palette of good quality materials that are preferably locally sourced.



Figure 6B: Modern town house elevations take inspiration from traditional patterns and proportions



Poor pastiche design with a scale, proportions and detailing that fail to achieve a contextual response



Different facing materials on the same standard building type undermines architectural integrity

# 6 High Quality Building Design Architectural Integrity

## Windows

6.3.1 The design and position of windows should be determined by the overall design approach and guided by both the external composition and internal daylight requirements. For example, a contemporary design typically incorporates a higher proportion of glazing with large windows and greater variety of fenestration which can make it appear light and airy. This is less appropriate in traditional designed buildings which are characterised by a more solid face.

6.3.2 Windows can contribute significantly to adding interest and the articulation of facades. For instance:

- Windows can create a light and airy impression and make a building appear less bulky;
- Grouping windows into vertical bands can help subdivide and break-down the scale of a building frontage;
- Windows that are set-back (revealed) within a facade cast shadows which can add visual interest and create a sense of structural depth that is not achieved with flush-faced windows; and

- Projecting bay windows provide a strong defining feature as well as additional depth.
- 6.3.3 However, if poorly designed or arranged, windows can undermine the appearance of facades:
- Too many different windows, particularly if they are inconsistently proportioned or positioned, can make a building appear overly fussy and poorly coordinated; and
  - Too many identical windows, especially on a large building, can look monotonous and bland unless it is compensated for by other articulating measures.

6.3.4 UPVC windows are less successful in design terms, particularly in traditional buildings due to their bulky frames and glazing bars. Wherever possible, timber should be used unless an alternative material is shown to be more appropriate.



Contemporary design typically incorporates large windows and greater variety of fenestration, which may be inappropriate in a more traditional design



Windows have been carefully organised in a logical hierarchy that graduate in size from the ground floor to the top floor



Vertically grouped windows provide elevational interest and help subdivide a frontage giving a strong rhythm when applied to a terrace of identical houses



The elevations benefit from deep window reveals that add interest through the play of light and shade



The classical styling is revealed as an unconvincing pastiche by top hung windows pretending to be sash windows



The lack of window articulation and absence of secondary facing material result in a bland façade. The elevations also suffers from inconsistently proportioned windows which incorporate fake glazing bars that undermine their authenticity

## 6 High Quality Building Design Architectural Integrity

### Dormer Windows and Rooflights

6.3.5 While dormer windows can sometimes be prominent features in the streetscene, care needs to be taken with their design, proportions and position on the roof. The choice of design should be informed by the character and appearance of the local vernacular.

6.3.6 Dormer windows should be visually subordinate to the roof slope, enabling a large proportion of the main roof to remain visible. Excessively wide dormers are likely to look unsatisfactory as they will often be out of proportion with the existing roof.

6.3.7 Dormer windows should normally be positioned below the ridge-line, and above the eaves line.

6.3.8 Rooflights that follow the roof profile can be an appropriate substitute for a dormer where it is important to retain the profile of the roof slope or avoid a dormer that break the eaves line. Care though needs to be taken to avoid them dominating the roof. Rooflights are best designed with a slender-profile that are flush with the roof slope.



Dormers can be used in new development to reflect local vernacular in a modern way.



Dormers should be an integral part of the design and in proportion with the facade as in these town houses



Dormer windows should be suitably sized and proportioned so that they are subservient to the roof



If dormers are too big this can result in a top-heavy appearance



Dormer windows that extend across the eaves generate additional rainwater downpipes which if integrated in the design can work harmoniously with the façade



If not planned for rainwater downpipes can disrupt an elevation especially if it is otherwise symmetrically organised

# 6 High Quality Building Design Architectural Integrity

## Roof Design

6.3.9 The predominant roof forms in the District are simple double-pitched roofs; these can be organised with gable or hipped ends and/or with gable-fronts. New development should respect these characteristics, while providing variety of roof forms to help give schemes diversity, particularly in larger developments. For instance, adopting a consistent roof-form in one street can help to distinguish it from another street with a different roof form.

6.3.10 Proposals should normally avoid:

- Shallow-pitched roof profiles (below 40 degrees) and visible crown-topped roofs on traditionally designed buildings as these are atypical to the character of the area and can generate a weak building profile; and
- Inconsistent roof pitches on the same or adjacent buildings as this can generate clumsy juxtapositions.

6.3.11 The roof form should also be influenced by sustainability/orientation considerations (refer to DG37 and case study five).



Historic vernacular - simple pitched roof on terraced properties in the District

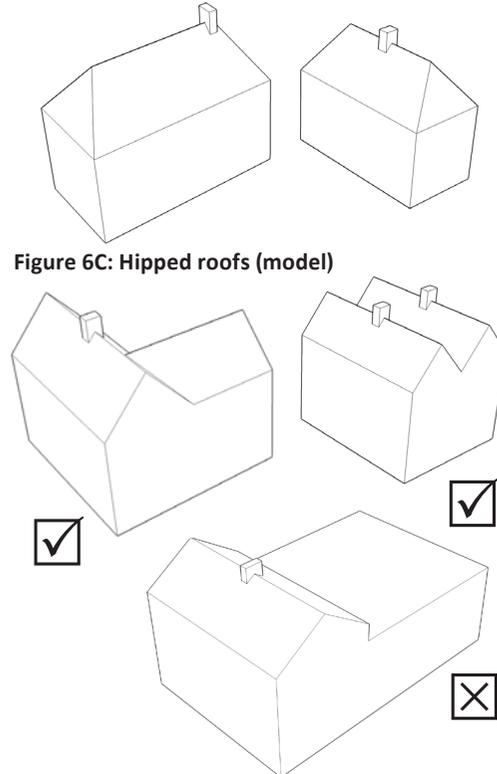

Figure 6C: Hipped roofs (model)

Figure 6D: Breaking down larger floorplan buildings into a number of simple roof profiles (model)



Roof articulation adds interest on the main frontage overlooking open space



Gable fronted roofs work more successfully for narrow fronted properties



Solar panels carefully integrated into the design of a south-facing roof



Clumsy juxtaposition of properties with inconsistent roof angles / over-dominant roof dormers



Crown topped roofs should be avoided particularly where they are visible from the street



Poorly proportioned detached houses with narrow fronts, deep plans and pitched roofs with high ridge lines generating over-large and mostly blank flanks

# 6 High Quality Building Design Architectural Integrity

## Chimneys

6.3.12 Chimneys are a traditional feature within Mid Sussex which contribute to the character of the area. Developments are encouraged to include chimneys where they contribute positively to the architecture and perform a function.

6.3.13 Chimneys can be used in modern ways such as part of a sustainability strategy for thermal stacks to aid ventilation in summer or, as flues serving wood burning stoves or, as a service core for gas outlets.

6.3.14 The position of chimneys should be influenced by the internal layout. Thermally a central position within the building optimises energy efficiency as there is less heat loss than if located on an external wall. However, consideration also should be given to their external articulating role, and historically this is commonly achieved by projecting the chimney at the gable end.



A functional chimney that is convincingly integrated into the building design



Contemporary chimneys designed to provide ventilation but also articulate the roofline



Fake chimneys should normally be avoided as they often look unconvincing and undermine architectural integrity

## Balcony Design

6.3.15 Balconies and Juliet balconies not only provide useful outside space or sense of the outside, they can help articulate a façade providing they are carefully organised and integrated; for instance, vertically grouped balconies can contribute to creating a rhythm and visual interest. Conversely, balconies can be inappropriate if they dominate an elevation by covering a large part of the frontage and/or if they extend horizontally across the façade.

6.3.16 Deep balconies that project too far from the main façade can appear to be poorly-integrated. They are often more successfully integrated if they are either recessed or partially recessed within the main façade, where they can provide additional sense of structural depth.

6.3.17 The design of the balustrading should both fulfil safety requirements and be designed to integrate well with the rest of the façade.



Recessed balconies integrated into design of building façade



Juliet balconies can add interest to facades while providing rooms with a greater connection to the outside



Balconies are inappropriately dominant on the façade and appear to be bolted-on

# 6 High Quality Building Design Architectural Integrity

## Facing Materials

6.3.18 Whilst architectural style varies within the District a prevailing characteristic of most successful buildings is a simple, restrained palette of materials, detailing and architectural features integral to the design. If too many materials are used facades risk appearing untidy or overloaded; on the other hand, if a façade lacks a contrasting material there is a risk of it looking bland.

6.3.19 Facing materials (particularly secondary materials) should be fully integrated and consistently used on all sides of buildings and not limited to just the front elevation as this can undermine the building's integrity and appear to be a bolted-on facade.

6.3.20 Materials should reflect the character of the area and the style of architecture adopted. It is often desirable for a new building to blend into its surrounds by using complementary materials that are used within the area and to ensure that the new building does not inappropriately draw the eye or undermine local distinctiveness.



Prevailing materials characteristic of Mid Sussex: clay tiles (all areas); sandstone typical of High Weald; red brick with headers (all areas) and flintwork (typical in southern part of District)

6.3.21 Good quality materials and fixings should normally be used. On traditional-styled buildings and those in sensitive locations (including those that are inter-visible from the surrounding countryside), natural materials including local clay tiles, weatherboarding, stock bricks and timber windows are appropriate and man-made alternative materials should be avoided particularly where they do not evoke the finish of natural materials.

6.3.22 There are normally opportunities to explore a wider range of materials on contemporary-designed houses however these should also normally be drawn from or influenced by the local context.

6.3.23 Render is not a typical material used in Mid Sussex and therefore should normally be avoided, at least as the principal facing material.



Attention is given to the detailing and materials in the above building facades



Render façades often do not age well unless they are well maintained



The clay hanging tile is inconsistently applied and appear to peel-away at the side. The roof tile also looks too bright in relation to the facing tile

# 6 High Quality Building Design Architectural Integrity

## Traditional Design Approach



Flint facing combines well with brick detailing



Sweet chestnut clad facades; care needs to be taken with the construction detailing to avoid irregular weathering



Buff brick is not typical in Mid Sussex; it has been accepted here as it echoes the colour of the adjacent sandstone-faced St Margaret's Convent and combines well with the (reconstituted) stone-framed / grey-painted windows



Natural clay hung (incorporating a beaver-tail pattern) tiles with local stock bricks and darker clay tiles employed on the roof

## Contemporary Design Approach



Grey cladding coordinates well with the slate roof, grey windows/doors and local red brick



Weatherboarding can be applied successfully on a more contemporary façade



Weatherboarding has been employed in a more contemporary manner



Clay hung tiles as well as brick can be effectively employed in a contemporary design. This design evokes the informal grouping of buildings and materials that might be found in a farmstead



# 6 High Quality Building Design Best Practice Case Study

## Case Study Six: Horsted Park, Chatham

### *Delivering architectural integrity*

#### **Overview**

A suburban edge site that takes its design inspiration from the farmyard clusters in Kent.

The design successfully creates an environment with a unique sense of place. In response to the site's semi-rural setting, the opportunity was taken to develop a series of new house types which reference the rural vernacular of Kent's farmsteads. Clusters of detached, semi-detached and terraced homes are arranged as a series of farmyard courts with fingers of accessible parkland, defining the edge and interface between each cluster.

The detailing of the landscape and building facades creates a distinctive and contemporary reworking of traditional building forms.

**Architect:** Proctor Matthews Architects

**Site area:** 4.1 Hectares

**Number of Homes:** 154

**Density:** 38 homes per hectare

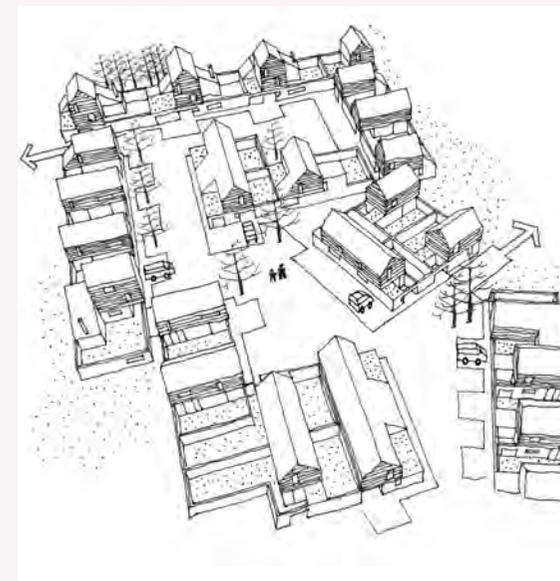

# 6 High Quality Building Design

## Height and Scale

### 6.4 Height and Scale

#### Principle DG39: Deliver appropriately scaled buildings

The scale of new buildings should relate to their context (rural or urban), their location within the hierarchy of routes and whether they act as a focal point, landmark or corner building and the topography of a site.

Subdividing a street frontage into a series of vertically proportioned bays helps avoid larger buildings, and extended frontages, appearing monolithic and provides them with a more human scale. The following measures should also be considered to reduce the scale of larger buildings:

- Articulating the upper floor(s) as a recessive element by employing a set-back and different façade treatment behind a parapet/solid balustrade that helps screen the full height of the building from street level.
- Stepping down the height of the building adjacent to lower scale frontages.

In existing less ordered street frontages, generating a consistent pattern of development may be less appropriate. In this context, subtle variations in height can be used to add visual interest. This can be achieved with differing ridge and eaves heights, as commonly found in traditional streets. Similarly, variations in frontage widths and plan forms can add further interest to the street scene.

It is often appropriate to emphasise a junction and terminate a street axis. This can be achieved by accentuating the façade treatment and/or exaggerating the vertical proportions of a façade either through clever articulation or, by raising the height of the building (at the corner or end of the axis) above the prevailing height.



Figure 6E: Development should reflect the scale, grain and diversity of the existing settlement



Figure 6F: Apartment buildings should respond to the scale, massing and grain of the context in a complementary way and avoid becoming overbearing

## 6 High Quality Building Design Height and Scale



This block has been sensitively designed to step down in height adjacent to an existing lower building



These blocks successfully break down their scale through vertical articulation that evokes the repeated rhythm of a run of terraced houses

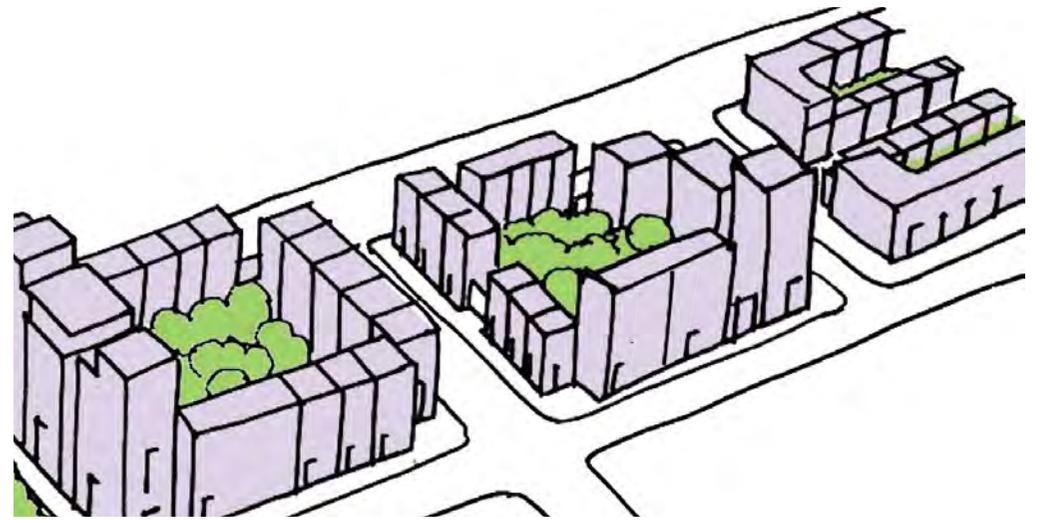

Figure 6G: Apartments should be proposed at appropriate locations within urban areas and add to the legibility of an area



These blocks of flats have been designed so they read as subdivided facades that evoke the repeated rhythm of a run of terraced houses and sit more comfortably adjacent to smaller buildings



The set-back top floor helps to reduce the scale of this building



This apartment block has been designed with no attempt to relate to the scale and form of the adjacent houses and has little underlying order or form

# 6 High Quality Building Design

## Active Frontages

### 6.5 Designing Buildings with Active Frontages

#### Principle DG40: Design buildings that respond to and animate the street space

Development should be designed to ensure that streets and public spaces have good levels of natural surveillance and are overlooked by ground floor habitable rooms and upper floor windows. Buildings should therefore be designed with open, active frontages that engage with and provide a public face onto the street and spaces. They should normally be organised with:

- Windows that directly overlook the public realm;
- Corner buildings that address both their street facades;
- Main entrances that face the street; and
- Boundary treatment that allows for street surveillance.

Conversely blank facades and unsightly gaps in street frontages should be avoided.

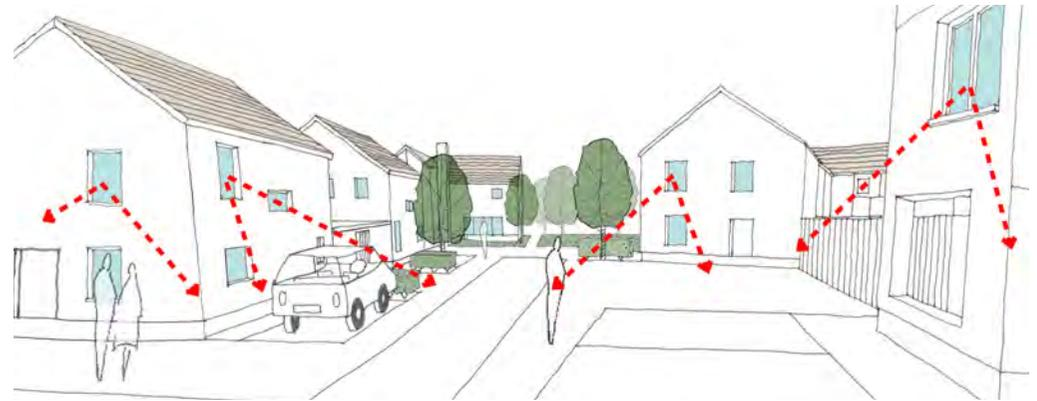
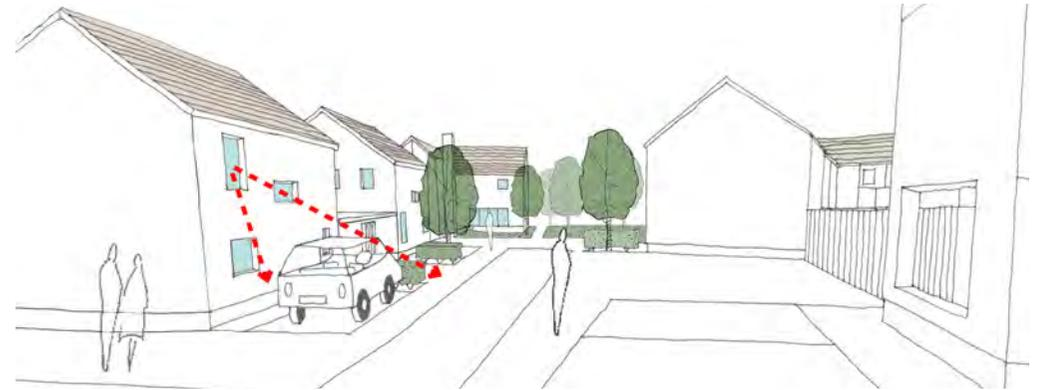

Figure 6H: Ensuring that all public areas are overlooked by adjacent buildings, to increase 'eyes on the street' will reduce the likelihood of anti-social behaviour



These houses address the corner well by organising the windows (and other features) so they formally address both return facades



Manor Road, Burgess Hill - Blank gables provide no natural surveillance of the street



The gable flank return at the end of the street a fully fenestrated façade that addresses the end of the axis and along with the houses on each side, overlooks and animates the street

# 6 High Quality Building Design Active Frontages

## Apartment Buildings

6.5.1 Apartment buildings within busy commercial streets in town centre locations should generally have non-residential uses at ground floor level and these should be designed to provide an 'active' frontage to the street.

6.5.2 Apartment buildings that do not incorporate ground floor non-residential uses should be designed to avoid bedrooms at the ground floor level facing the public realm as this can reduce privacy for residents and reduce passive surveillance of the public realm. It is often more appropriate to incorporate maisonettes on the ground and first floor of apartment buildings to avoid such scenarios.

## Addressing Corners

6.5.3 Attention should be given to corner buildings (those located on the intersection of two streets). These buildings should be designed so that they 'turn the corner' providing active fully fenestrated frontages on both streets. Corner buildings are often well defined by 'L' shaped buildings that help maintain the continuity of the built frontage.

6.5.4 Applicants should demonstrate how the design of corner buildings will aid legibility. Exposed, blank gable ends with no windows fronting the public realm will not be acceptable.

6.5.5 The rear elevations of corner houses are often more visible than other houses because of the gap in the street frontage to accommodate the rear garden. Additional care therefore also needs to be given to their articulation.

Building designed to turn the corner to avoid blank gable ends



Figure 6I: Gable ends which incorporate windows provide overlooking

Figure 6J: By extending plot 3 to turn the corner and setting back plot 2 the proposal provides sufficient space for a garden. By providing plot 2 with a single storey element and an adjoining brick wall, it further assists with maintaining a built frontage

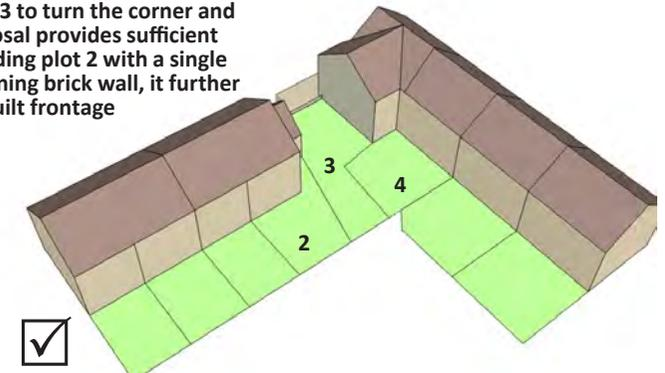

The curved corner has been designed to respond to the turn in the road and the step-up in height provides additional punctuation



Mixed use town centre development that appropriately employs non-residential use at ground floor and residential uses above

## 6 High Quality Building Design Building Interface



### Boundary Treatments

6.5.6 In town or village centre locations or mews style developments, buildings may be located directly to the rear of the footway or public realm, but usually properties should have a boundary that defines public and private space.

6.5.7 Boundary treatments should be reflective of the area and local traditions in terms of height, structure and materials; however, this should be balanced with the need for natural surveillance. For larger developments boundary treatments should be coordinated to contribute to the character of the street but allow for some variety and individuality.



Rear boundaries facing the public realm need to be a secure height to safeguard the garden and attractively designed typically employing a brick wall and planting



A low hedge is often an attractive and appropriate front boundary providing provision is made for its future maintenance

Low brick walls and railings define the front boundary at Wilmington Way, Haywards Heath

Chestnut post and rail fencing is a characteristic feature in more rural parts of the District



The use of close panel timber fencing to define the highway boundary is unacceptable



Lack of a defined edge to the housing plots diminishes the quality of the street environment

# 6 High Quality Building Design

## Active Frontages

### Building Entrances

6.5.8 Main entrances to houses, ground floor flats, communal entrances for flats and non-residential uses should directly face onto the street and be clearly visible from the public realm; they should also be welcoming and easily identifiable to help improve legibility.

6.5.9 The scale and style of an entrance should relate to its function. The more important the function of the building, the more impressive the entrance should be. For example, a public building should have a larger and more prominent entrance than a house.

6.5.10 Canopies have an important role as they give entrances both shelter and additional prominence. However, they should make a positive contribution by being well integrated with the building façade. This can also be achieved successfully with recessed entrances.

6.5.11 Entrances to shared stair cores in apartment buildings should be accessed directly from the street and should be generously proportioned, well-lit by natural light and naturally ventilated.

6.5.12 Ground floor dwellings within apartments can be designed with individual entrances direct from the street. This increases the animation of the public realm and reduces the numbers of dwellings served by communal cores.

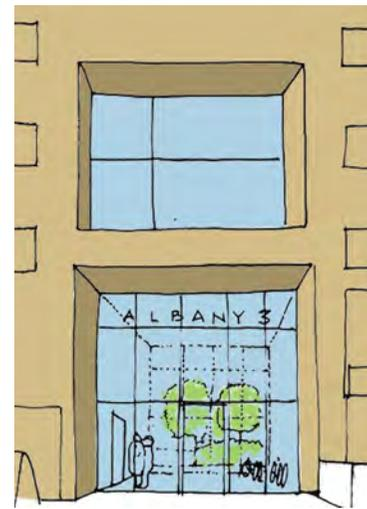

Figure 6K: Entrances to important buildings and non-residential uses should be more civic in their appearance



Building entrances should be at street level, or slightly elevated but not below street level



Entrances which are well defined by their canopies serving an apartment block and house (respectively)



The entrances to these residential blocks are not apparent from the street



Elevating the entrance has divorced it from its street threshold and there appears to be no consideration for disability access

# 6 High Quality Building Design Responding to Topography

## 6.6 Designing Buildings on Sloping Sites

### Principle DG41: Addressing sloping sites

Buildings should be designed so they elegantly respond to the gradient of sloping streets while also facilitating level /step-free access to ground floor entrances allowing the main façade to fully address the street. Front elevations and rooflines should normally be evenly stepped so that they echo the angle of the slope and avoid both prominent retaining walls and over-large flank elevations.

The apparent size of side elevations can be inappropriately accentuated by sloping sites. Consideration should be given to reducing the impact through the roof design. For example, the extended gable-flank wall generated by a standard double pitch roof, should normally be avoided. As well as helping to model the front elevation, hipped rooflines or gable-fronted houses should instead be considered as they reduce the massing of the flank elevations.

New buildings on cross slopes that run from the front to the back of building plots, also need to be carefully designed. They should deliver level access to the building from the rear garden as well as from the street, while also avoiding over-large retaining walls and fences along the rear boundaries. On steep slopes, this can be addressed by split level buildings. On shallower slopes, a gently angled garden and stepped/landscaped rear boundary can sometimes be an acceptable arrangement providing that a flat patio area is provided and the building on the upper part of the slope does not overwhelm the building and garden (in terms of its proximity and/or relative height) on the lower slope.

Additional consideration should be given to accommodating parking on sloping sites and avoiding retaining structures around them. Sloping sites can sometimes provide the opportunity to discreetly accommodate under-croft parking within a split-level arrangement.



Buildings that respond well to their sloping sites with frontages that step in an ordered and harmonious manner

Additional care needs to be taken to accommodate awkward slopes. In this example inadequate consideration has been given to the configuration of the front threshold and the back gardens.

# 6 High Quality Building Design Building Services

## 6.7 Accommodating Services

### Principle DG42: Consider the location and design of services and external pipes

Modern services (including external pipework, flues, vents, meter cupboards, satellite dishes and aerials) can create a cluttered appearance and detract from the design of an otherwise successful development. Careful consideration, therefore, needs to be given to their location and positioning on buildings at the initial design stage.

Rainwater downpipes can positively contribute to the articulation and rhythm of a façade by defining the plot widths of semi-detached and terraced houses or can be employed to help reduce the scale of apartment buildings through careful and regular positioning within the façade.

Utility meters should be carefully planned so they are conveniently located and unobtrusive; preferably grouped together and avoiding the frontage whenever possible.

Apartment buildings should normally have a communal aerial and satellite dish if cable TV is not available, and a condition should be attached to the planning permission to this effect.



Rain water pipes have been positively accommodated to define the individual building frontages and thereby generate underlying rhythm



Little thought has been given to the positioning of rain water pipes, which is especially an issue when the eaves line is broken



Meter boxes are prominent on building frontages

# 6 High Quality Building Design CHECKLIST (Part One)

## How to use

This table provides a checklist for use by both the applicant and planning officer to check that appropriate consideration has been given to the **design of buildings** within a proposal.

**PROCESS:** Have you read, understood and applied the principles set out above?

**PROCESS:** The adjacent table summarises the key principles set out within this section and can be used by applicant and officer as a checklist.

The applicant is expected to meet the requirements of all relevant Principles (ie a tick in each box) or provide a justification for failure to do so.

PRINCIPLE	DESCRIPTION	CHECK
<b>Response to Character</b>	Do the proposals demonstrate a response to the character of the area as identified within the Character Study in Section 2?	
<b>Response to Constraints and Opportunities</b>	Do the proposals demonstrate a response to the site constraints and opportunities as identified within the Site Appraisal in Section 2?	
<b>DG37: Sustainable Buildings</b>	Are buildings designed to minimise the use of resources and energy?	
<b>DG38: Respond to Context</b>	Has the applicant demonstrated an architectural approach and identity borne from the place and reflected through the Character Study?	
	Does the new development adopt a simple form in-keeping with the character of the area? If not is the reason justified?	
	Is the choice of window design appropriate to the overall design approach?	
	If balconies are proposed do they integrate well with the rest of the facade?	
	Does the roofscape proposed reflect the simple roof structures characteristic within the District?	
	Are larger buildings broken up into a series of smaller spans or modules of a simple form to ensure the roof does not dominate the building or surrounding area?	
	If chimneys are incorporated into the design are they reflective of the character of the area?	
	If dormers are incorporated into the design are they reflective of the character of the area?	
	Are they positioned to line up with openings on the main façade?	
	Is the palette of materials and detailing proposed of high quality and reflective of the character of the area as established through the Character Study?	
<b>DG39: Scale and Height</b>	Does the design generally reflect or respond to the scale of the existing settlement and positively contribute to the character as identified in the Character Study in Section 2? If not has a strong justification been provided?	
	Does the scheme incorporate variations in height responding to the location within the proposal, for instance reflecting the street hierarchy, enhancing legibility of an important corner or node or emphasising a particular use?	
	Is the location of any apartment buildings justified and justifiable?	

## 6 High Quality Building Design CHECKLIST (Part Two)

PRINCIPLE	DESCRIPTION	CHECK
<b>DG40: Active Frontages</b>	Does the development ensure that all streets and public spaces have good natural surveillance from buildings?	
	Are active ground floor uses proposed on busy commercial streets / town centre locations?	
	Does the scheme avoid exposed, blank gable ends with no windows fronting the public realm?	
	Do corner buildings 'turn the corner' providing frontage to both streets?	
	Has the applicant demonstrated how the use of corner buildings has been considered in order to aid legibility?	
	Are all property entrances directly onto and easily visible from the public realm? Are they legible and welcoming?	
	If there are apartments within the scheme are their communal entrance cores generous, well lit by natural light and naturally ventilated?	
	Does the development clearly define public and private space through the use of appropriate boundary treatments? If not, is this justified?	
	Are these boundary treatments reflective of the area as established in the Character Study?	
<b>DG41: Sloping Sites</b>	Does the development respond to a sloping site with the building stepping to follow the slope where appropriate?	
<b>DG42: Utility Meters / External Pipes</b>	Are utility meters located where they are both convenient and unobtrusive?	
	Are external service pipes and other apparatus grouped together and discretely located on elevations so that they are not prominent?	



# 7 Business Parks / Employment Areas



# 7 Business Parks / Employment Areas Layout



Office buildings set within green environment at Milton Park, Didcot

## 7.1 Introduction

7.1.1 The District has many commercial / employment areas distributed throughout the District. However, the largest business parks lie primarily in the three town centres. The District Plan anticipates significant employment growth over the plan period including the development of a 50ha Science and Technology Park at Burgess Hill. The way that business and employment areas are laid out and the design of individual employment buildings can have a significant impact on both their success, the amenity for employees and on the surrounding area.

7.1.2 This Chapter outlines how employment sites and buildings should be designed to respond to their setting, minimise visual impact whilst delivering welcoming environments that are accessible by sustainable modes and reduce their impact on the environment.

## 7.2 Layout of New Employment Areas

### Principle DG43: Deliver attractive and clearly laid-out employment areas that are sensitive to their surrounds

New employment areas should be sensitively located and designed. They should utilise the principles as set out in Chapters 2 to 6. However, because of their size and scale, care needs to be taken to ensure that new commercial buildings do not adversely impose upon their surrounds. Landscape Visual Impact Assessments should be undertaken during winter months to establish the impact of the development on the landscape and particularly in relation to views from public viewpoints in the surrounding countryside and townscape.

A generous landscape buffer strip will normally be needed adjacent to the boundary to screen and soften the buildings from the surrounds.

Development in employment areas should also normally be laid-out with:

- The public realm employing a coherent and common design language;
- New buildings set within appropriate landscaping with native trees and shrubs defining the street environment and pedestrian realm;
- Open spaces and key landscape features located centrally where they can form a focus for the site and designed to provide amenity for employees;
- A clear structure of connected streets incorporating footways and cycle routes with buildings fronting the streets wherever possible; and
- Parking and servicing softened/screened with vegetation and located at the rear of buildings where it has less impact upon the public realm.

# 7 Business Parks / Employment Areas Layout

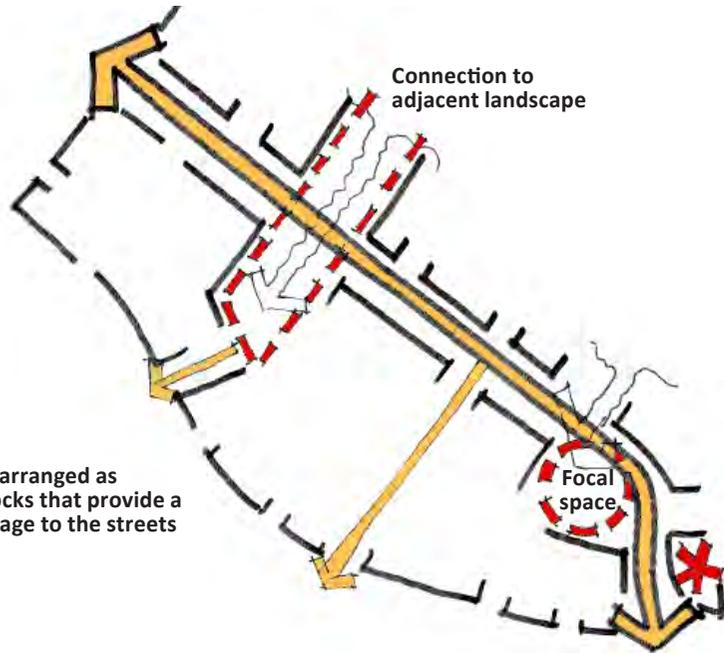

Figure 7A: Concept for employment area indicating primary route as boulevard, central space and key gateway buildings



Figure 7B: Layout plan showing indicative block layout with frontage and entrances overlooking the boulevard



Figure 7C: Service yards and parking should be internalised within the perimeter block to reduce impact on the street environment

# 7 Business Parks / Employment Areas Building Design

## 7.3 Design of Commercial Buildings

### Principle DG44: Design of commercial buildings

Employment buildings should respond positively to the character and architectural traditions of the District in terms of scale, mass, form, materials and detailing (refer to the principles in chapter 6).

Within town centres offices must present a positive interface with the street with prominent entrances and design features to help to animate the street space.

On business parks and industrial estates as a general principle, the landscape and public realm should form the dominant feature within employment areas with the buildings forming a more neutral background. As such, the design of simple, rectilinear buildings within the landscape is promoted.

New commercial buildings should reduce their impact upon the environment by incorporating the sustainability principles set out in DG37.

The design of commercial buildings must consider:

- Measures to create a more human scale for example through the vertical articulation / subdivision of the facade;
- Careful selection of facing materials that blend with the surroundings and/or complement existing adjacent buildings.
- The location of reception areas and office space so that it positively contributes to the surveillance of entrance areas and forecourts;
- The location and coordination of signage to minimise its impact and ensure that signage on buildings is not overbearing on the surrounds or out of proportion with the scale of buildings; and
- Measures to mitigate the impact of their height/bulk. For example, low profile pitches / barrel vault roofs may be preferable to angular flat roofs. Green roofs should be considered where appropriate.



Design consideration has been given to the quality of the landscaping and the articulation of building facades respectively in rural-edge (ABOVE) and town centre (BELOW) schemes

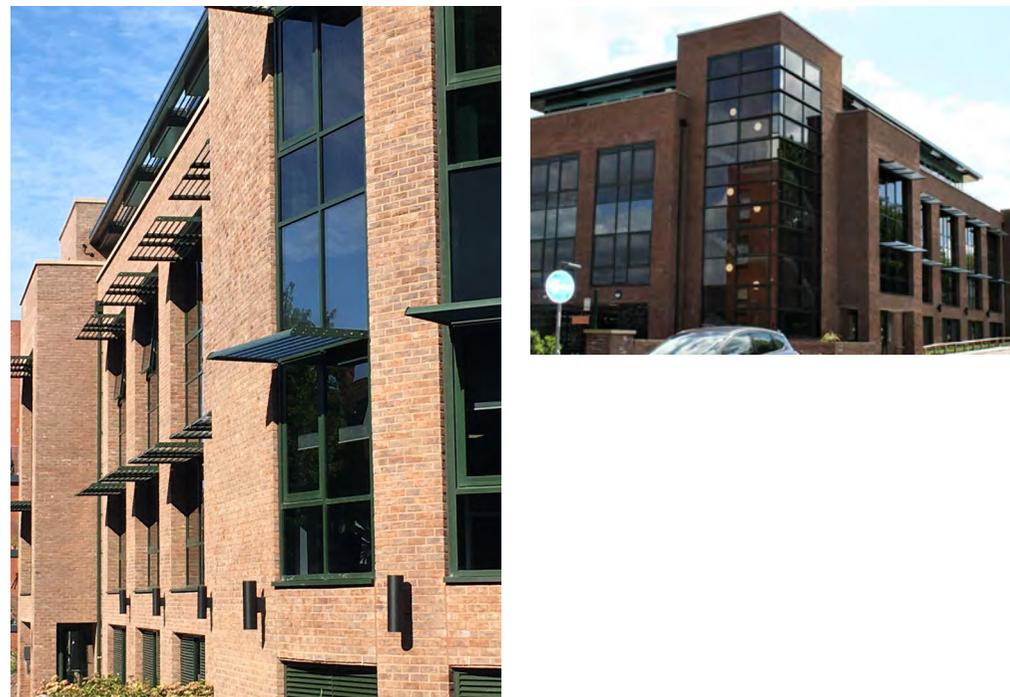

# 7 Business Parks / Employment Areas CHECKLIST

## How to use

This table provides a checklist for use by both the applicant and planning officer to check that appropriate consideration has been given to design and layout when preparing a proposal for **business parks and employment areas**.

**PROCESS:** Have you read, understood and applied the principles set out above?

**PROCESS:** The adjacent table summarises the key principles set out within this section and can be used by applicant and officer as a checklist.

The applicant is expected to meet the requirements of all relevant Principles (ie a tick in each box) or provide a justification for failure to do so.

PRINCIPLE	DESCRIPTION	CHECK
<b>DG43: Layout of Employment Areas</b>	Has the layout of employment areas (where appropriate) been designed taking a landscape led approach that links to natural assets, creates open spaces for workers and minimises the impact of car parking and servicing?	
	Has the landscape and visual impact of the building been considered and is it sited and planting proposed where necessary to mitigate any visual impact?	
<b>DG44: Commercial Buildings</b>	Do employment buildings (where appropriate) respond positively to the character and architectural traditions of the district in terms of scale, mass, form, materials and detailing?	
	Is the ground floor of commercial buildings articulated to create a more human scale with entrances generous and welcoming?	
	Do reception areas and office space positively contribute to the surveillance of entrance areas and forecourts?	
	Is signage on commercial buildings in proportion with the scale of building and appropriate to the streetscape?	
	Has adequate consideration been given to long term sustainability including the use of renewable energy?	



# 8 Residential Amenity



# 8 Residential Amenity

## Privacy



Particular care needs to be taken to avoid direct overlooking from balconies and privacy screens should be sensitively integrated into the design of the facade and not bolted-on

### 8.1 Introduction

8.1.1 The design of new development can have a direct impact on quality of life. As set out in District Plan policy DP26, new development should therefore be designed so that it does not cause significant harm to the amenity of existing and future residents.

8.1.2 This chapter sets out guidelines that cover privacy, daylight/sunlight standards, protection from pollution and the provision of external amenity space.



The privacy of the ground floor flats is aided by a generous planted boundary that defines the private realm while also facilitating an outlook across the public realm

### 8.2 Privacy

#### Principle DG45: Privacy of existing and future residents

Applicants will need to demonstrate how privacy will be achieved between new and existing developments.

The following elements can have an impact on privacy:

- The relationship of buildings to each other including the positioning and design of windows and doors;
- The topography and relative height of adjacent buildings;
- The provision of good noise insulation;
- The relationship of the parking, gardens, front defensible space, balconies with the adjacent buildings; and
- The position and arrangement of habitable rooms.

Direct overlooking of private amenity space from habitable rooms in neighbouring properties should normally be avoided.

Set-back upper floors, recessed balconies and generous internal courtyards can all help to deliver higher densities whilst respecting privacy. Because they are usually more visible, the privacy of ground floor flats should particularly be considered, and the provision of dedicated private rear gardens will often be necessary.

## 8 Residential Amenity

### External Amenity

#### 8.3 External Amenity Space

##### Principle DG46: Provide attractive and usable external amenity space for all homes

All dwellings should normally have access to usable private outdoor amenity space that is appropriate to the location and the type and size of accommodation. This can be provided in the form of a private garden, patio or balcony. Where no private amenity space is provided, either a generous private communal garden or adjacent public open space should be provided. Communal gardens should be incorporated to the rear of apartment blocks to provide visual amenity as well as outdoor space for residents with soft landscaping prioritised over areas of hard standing. Consideration should also be given to the provision of outdoor seating, eating, drying and growing space.

Private outdoor amenity space should normally be designed as an extension of the living space with direct access provided and should avoid being unduly overshadowed.

Ground floor homes in apartment blocks should normally have access to a well-defined, rear, private area that provides both 'defensible space' and good quality external amenity.



Apartment block benefiting from private communal space



Apartment blocks organised around a central square in Bolnore Village where they benefit from the immediate access of outdoor space

# 8 Residential Amenity

## Amenity

### 8.4 Daylight / Sunlight

#### Principle DG47: Provide homes with sufficient daylight and sunlight

All dwellings should benefit from daylight and sunlight levels that conform to BRE (Better Regulation Executive) standards. Single aspect north-facing apartments should normally be avoided as they receive insufficient sunlight. South facing apartments will need to be carefully designed to avoid overheating problems.



Buildings should be designed with sufficient separation distance to avoid privacy problems and a deficiency of daylight/sunlight

### 8.5 Noise, Air and Light Pollution

#### Principle DG48: Design to minimise the impact of noise, air and light pollution

Noise disturbance and air/light pollution can be reduced through careful design including the following measures:

- Orientating or organising buildings so that the principal habitable rooms and sitting-out areas face away from the source of the pollution;
- Incorporating design features such as recessed balconies and acoustic lobbies;
- Constructing barriers such as garages or walls between the source of the pollution and dwellings;
- Using landscape features (including trees and earth mounding) to absorb noise/air pollution and deflect light; and
- Avoiding parking where it will create noise and headlight nuisance from vehicle movements.



Tree planting helps to soften the impact of traffic along the busy Queen Elizabeth Avenue in Burgess Hill

# 8 Residential Amenity CHECKLIST

## How to use

This table provides a checklist for use by both the applicant and planning officer to check that appropriate consideration has been given to **residential amenity** within a proposal.

**PROCESS:** Have you read, understood and applied the principles set out above?

**PROCESS:** The adjacent table summarises the key principles set out within this section and can be used by applicant and officer as a checklist.

The applicant is expected to meet the requirements of all relevant Principles (ie a tick in each box) or provide a justification for failure to do so.

PRINCIPLE	DESCRIPTION	CHECK
<b>DG45: Privacy</b>	Does the proposal demonstrate that privacy will be achieved for new and existing residents?	
<b>DG46: External Amenity Space</b>	Does the proposal provide suitable and useable external amenity space for all residents?	
	Is private outdoor amenity space designed as an extension of the living space with direct access provided?	
<b>DG47: Daylight / Sunlight</b>	Do all dwellings benefit from daylight and sunlight levels that conform to BRE standards?	
	Does the proposal avoid providing north facing single aspect apartments and if south facing single aspect apartments are proposed are these designed to avoid overheating?	
<b>DG48: Noise, Air and Light Pollution</b>	Is the proposal designed to minimise the impacts of noise, air and light pollution?	



# 9 Household Extensions



# 9 Household Extensions Planning and Designations



## 9.1 Introduction

9.1.1 Household extensions can have a significant impact on the character and appearance of a dwelling and the street or area in which it is set. This chapter examines the design approaches that should be considered when extending a dwelling

9.1.2 Extensions can positively contribute to the sustainability agenda by providing the opportunity to re-purpose and refurbish and give new identity to existing buildings while avoiding the normally greater environmental costs associated with demolition and redevelopment.

9.1.3 The Council's Planning Service can advise on whether planning permission is required for household extensions and alterations. Some smaller-scale extensions may constitute 'permitted development' which means they do not need planning permission; however, this does not apply if a building is Statutorily Listed or is located within a Conservation Area or Area of Natural Beauty or subject to an Article 4 Direction. In these cases, some forms of alteration that would otherwise be classed as permitted development will require planning permission and/or Listed Building Consent. Applications that affect a Listed Building will also require a Heritage Statement.

## REFERENCES

Historic England Good Practice Advice Note 2 – Managing Significance in Decision Taking in the Historic Environment

9.1.4 If planning permission is required the Council has a **validation checklist for householders** to help people in preparing applications and ensure all necessary information is included.

9.1.5 Building Regulations approval may also be required for any extensions or alterations to a dwelling. Advice on Building Regulations can be provided by the Council's Building Control Service.

9.1.6 Extensions to buildings that are Statutorily Listed or located within a Conservation Area can be harmful if their significance is not fully understood, and the advice of the Council's Conservation Officer should be sought at the pre-application stage. More information on how to understand the significance of a heritage asset can be found in the **Historic England Good Practice Advice Note 2 – Managing Significance in Decision Taking in the Historic Environment** and West Sussex Historic Environment Record.

9.1.7 Householders are encouraged to make their extensions as energy efficient and sustainable as possible, and to incorporate where appropriate the design principles set out in DG37 of chapter 6 and in other relevant national and local policy guidance.

# 9 Household Extensions

## Local Character and Neighbours

### 9.2 Design Principles

#### Principle DG49: General principles for extensions

Extensions should respond to the design of the original dwelling and applicants will be expected to demonstrate how local character has informed the design proposal. Extensions should also normally be designed to be well-integrated with the existing scale, form and massing allowing the original building to remain the dominant element of the property whether it has one or several additions.

Extensions should typically use simple, uncomplicated building forms to complement and coordinate with the scale, form and massing of the original dwelling. The design approach may benefit from coordinating with the existing pattern of window and door openings as well as employing facing materials to match those of the existing dwelling. Otherwise it should demonstrate the appropriateness of the alternative approach.

Extensions should not result in a significant loss to the private amenity area of the dwelling.

There are two general approaches to extending a property:

- Designing in the style of the existing building by closely matching its facing materials, architectural features, window sizes and proportions; and
- Designing in a contemporary style that takes its cues from key aspects of the existing building that might include its underlying form and proportions, facing materials, window design and other specific architectural features. The success of this approach is particularly reliant on high quality facing materials and finishes, and this will normally need to be demonstrated through detailed elevations and section drawings.

Both approaches can create successful, well-designed extensions that can be mutually beneficial to both the house and the wider area.

All extensions and alterations should consider their impact on neighbouring properties (refer to Chapter 8 on residential amenity).

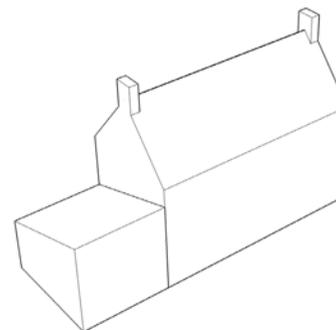

Figure 9A: The scale and massing of the extension bears no relationship to the existing dwelling

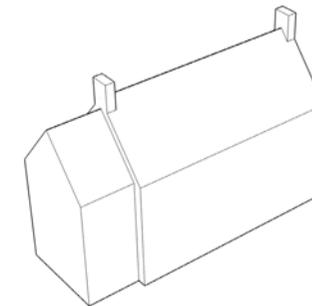

Figure 9B: The extension has an appropriate scale and massing in relation to the original dwelling

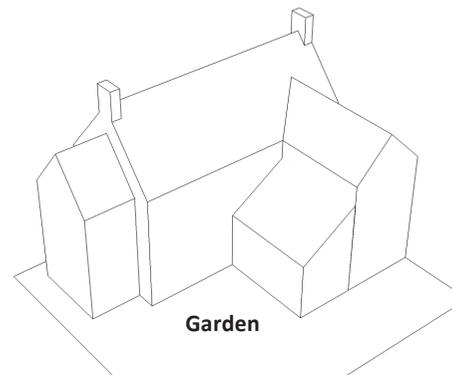

Figure 9C: Multiple extensions over time can have a compound impact and overwhelm the original dwelling

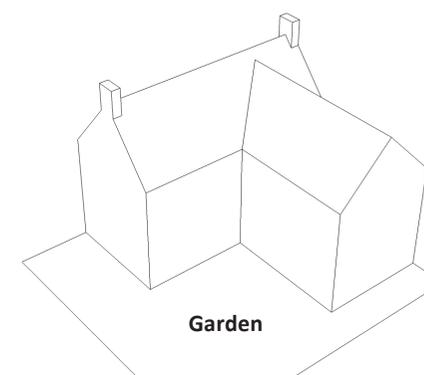

Figure 9D: The size of the extension risks overwhelming the original dwelling and may result in significant loss of garden

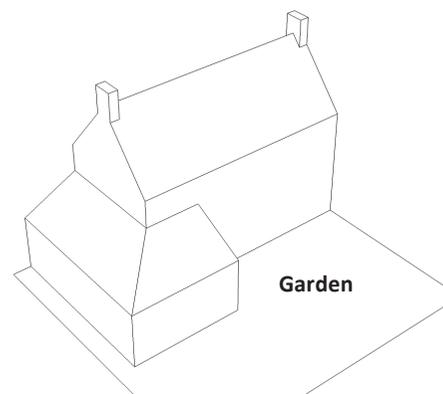

Figure 9E: Extensions that wrap around an existing dwelling can undermine the integrity of the original architecture

# 9 Household Extensions

## Front and Side Extensions

### Principle DG50: Front and side extensions

Front and side extensions are typically visible from the public realm and will be resisted where they have an adverse impact on the street scene or the appearance of a dwelling.

#### Front extensions

Front extensions are more likely to be acceptable where the building line is staggered or where the dwelling is set well back from the road. They are less likely to be acceptable in streets with a strong consistent building form as they risk disrupting the underlying order.

Where front extensions are considered acceptable, they should normally be limited to a modest single storey or porch-type extension that reflect the character of the existing property.

#### Side extensions

Side extensions should normally be subservient to the original dwelling and typically be set-back from the front of the house to help define the original building.

The gaps between dwellings can sometimes positively contribute to articulating (for example, through the consistent rhythm of repeated houses) and adding interest in a street frontage or by providing views / visible connections to the surrounding countryside. Side extensions will therefore need to appropriately respond to the character of the street form and will not normally be accepted where they close an important gap and view.



Successful two storey extension complements the original dwelling (above and right above)



Front extensions can often detract from the appearance of the dwelling



Successful single storey extension which is subservient to the original dwelling

## 9 Household Extensions

### Rear Extensions

#### Principle DG51: Rear extensions

Rear extensions which are not visible from the street and do not negatively impact on neighbouring properties can be expressed in many forms, including by adopting a contemporary architectural approach. With reference to DG49, they should nevertheless have consideration for the character of the existing building and the relationship of the extension with the side boundaries and adjacent buildings and gardens.



A contemporary rear ground floor extension to a Victorian property



Design of rear ground floor extensions respond to the form of the original property

# 9 Household Extensions

## Roof Extensions



Dormers successfully integrated into the roof to provide additional space

### Principle DG52: Loft conversions and roof extensions

A loft conversion is a space efficient means of extending the amount of living accommodation in a dwelling. Roof accommodation is normally reliant on dormer windows and rooflights to provide light and ventilation. However, if they are out of scale or out of character with the roofscape and proportions of a dwelling they can have an adverse impact on the character of both the dwelling and the streetscape.

The roof pitch and form are intrinsic to a building's character and roof extensions should be sensitive to this. Roof extensions and dormer windows that alter the existing ridge of the roof or significantly alter the roof profile of a building will not normally be acceptable, particularly on the front roof slope, and where there is a strong established roofline.

Where a clear rhythm of fenestration is established, the position and proportion of dormer windows should respond to existing windows and / or doors.

Further guidance on dormer windows and rooflights is provided in chapter 6 under sections 6.3.5 to 6.3.8.

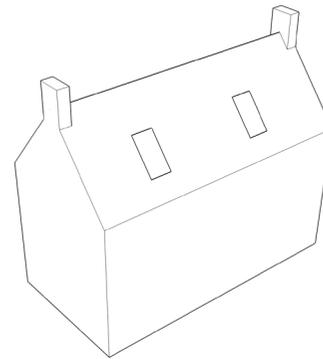

Figure 9F: Loft conversion incorporating rooflights

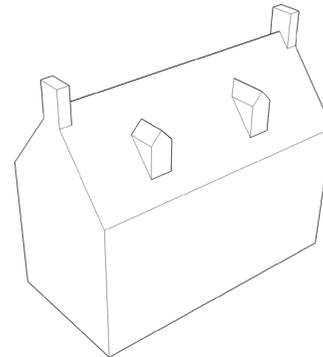

Figure 9G: Loft conversion incorporating dormers

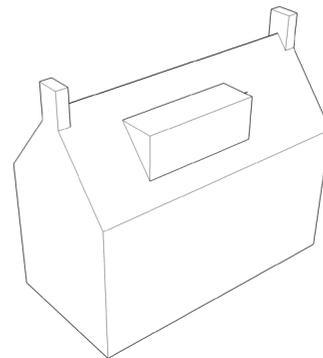

Figure 9H: Large flat roofed single dormer out of scale with the original dwelling



Dormers successfully integrated into the roof to provide additional space



The dormers in the foreground were added and are too big and top heavy; the dormers in the background are by contrast appropriately sized



This over-sized dormer undermines the shape and symmetry of this gable frontage.

# 9 Household Extensions CHECKLIST

## How to use

This table provides a checklist for use by both the applicant and planning officer to check that appropriate consideration has been given to the design of a **household extension** as part of an application.

**PROCESS:** Have you read, understood and applied the principles set out above?

**PROCESS:** The adjacent table summarises the key principles set out within this section and can be used by applicant and officer as a checklist.

The applicant is expected to meet the requirements of all relevant Principles (ie a tick in each box) or provide a justification for failure to do so.

PRINCIPLE	DESCRIPTION	CHECK
<b>Responding to Local Character</b>	Has the applicant demonstrated how the proposal responds to and respects the character of the area and the immediate neighbourhood?	
<b>Consider your Neighbours</b>	Has the applicant considered and demonstrated that the proposal does not cause significant harm to neighbouring properties in relation to overshadowing, privacy or an oppressive or overbearing impact?	
<b>DG49: Responding to Original Property</b>	Is the extension a simple, uncomplicated building form that compliments and coordinates with the scale, form and massing of the original dwelling? The original building should remain the dominant element of the property.	
	Do the materials proposed match those of the existing dwelling or has the applicant demonstrated the appropriateness of the alternatives proposed?	
	Is the roof form appropriate to the original dwelling? Generally this should be constructed with the same angle of pitch as the existing roof.	
	Does the proposed extension respond to the existing pattern of window and door openings?	
<b>DG50: Front and Side Extensions</b>	Does the front extension, canopy or porch reflect the character of the property in terms of scale, details and materials?	
	Does the side extension respond to the character of the street?	
	Does the side extension retain important gaps within the street scene and avoid creating a 'terracing effect'?	
<b>DG51: Rear Extensions</b>	Does the rear extension respond to the character of the existing dwelling and avoid impacting on adjacent buildings and gardens?	
<b>DG52: Loft Conversions and Roof Extensions</b>	Are any proposed dormer roof extensions set within the roof slope?	
	Does the position and proportion of dormer windows respond to the location of existing windows and/or doors?	



# 10 Building Conversions



# 10 Building Conversions

## Introduction

### 10.1 Introduction

10.1.1 Over time, some buildings become vacant or under-used because they cannot be used effectively for their original function. Conversions allow for the re-use of existing buildings to preserve their contribution to their urban or rural context while contributing to the sustainability agenda by capturing the embodied energy associated with the building's original construction, and avoiding the wider environmental costs linked with demolition and redevelopment. Re-purposing of buildings can also give them an interesting new identity. The Council therefore support the re-use of buildings when they make a positive contribution to the character of an area.

10.1.2 This chapter covers the main types of building conversions in Mid Sussex which fall under the following two categories:

- Conversion of traditional buildings with heritage value into residential and non-residential uses; and
- Conversion of office buildings to residential use.



The former convent at Grosvenor Hall in Haywards Heath has been sensitively converted to residential use



East Grinstead's Chequer Mead Community Arts Centre is a converted school building

# 10 Building Conversions

## Conversion of Traditional Buildings

### REFERENCES

Historic England guidance on Adapting Traditional Farm Buildings



A residential conversion of a Victorian school



A residential barn conversion that retains the original openings



Water tower successfully converted to residential use

## 10.2 Conversion of Traditional Buildings with Heritage Value

### Principle DG53: Principles for conversions of traditional buildings with heritage value

This guidance applies to traditional buildings that may be statutorily listed or unlisted with local heritage value.

The primary objective of all conversions of traditional buildings must be to retain the character and appearance of the original building, and its defining architectural characteristics.

Non-residential uses are typically easier to accommodate as they tend to require less significant changes to the fabric of the building.

Conversion to residential use may seek compromises in terms of the layout and the provision of natural light into all habitable rooms, that could detract from the original architecture. The introduction of conspicuous domestic features such as chimneys, satellite dishes, aerials, porches and additional window or door openings are often out of character with the original building and, wherever possible, such features may need to be avoided. Crisp contemporary alterations, if well detailed and sensitively integrated, can nevertheless work well while allowing the original structure to be clearly defined.

Especially in listed buildings, the original internal wall divisions should be retained wherever possible and the introduction of additional walls or floors should be kept to a minimum. Existing window openings and window detailing should normally be retained and refurbished.

Where additional floors are introduced, they should avoid cutting across tall windows in such a way as to be visible from outside the building or significantly affect the spatial qualities.

Large extensions or ancillary buildings are sometimes less appropriate for conversions particularly if they dominate or detract from the character or setting of the original building and so detract from its character.

Where appropriate, existing ancillary buildings should be re-used such as for garages and ancillary domestic buildings, to avoid the need for new buildings. The Landscaping and boundary treatments should not detract from the character or layout of the original building.

The structural integrity of a building will be a factor in determining whether it is capable of conversion without substantial rebuilding or extension; this may need to be demonstrated in a structural report.

# 10 Building Conversions

## Office to Residential

### 10.3 Office to Residential Conversions

#### Principle DG54: Converting office buildings to residential

Office to residential conversions are allowed under 'permitted development'. However, they often involve alterations to elevations and / or extensions that require planning permission.

The conversion of purpose-built office blocks typically generates technical challenges which may necessitate alterations requiring a planning application. The transition into self-contained flats results in additional amenity, parking and storage requirements that should be considered at the outset of the design process: for example, office buildings are typically deeper plan than residential buildings and rely on artificial lighting and air conditioning for ventilation; consequently, they are likely to require extensive modification to allow enough daylight and natural ventilation.

When a planning application is required, applicants should demonstrate how these issues may be overcome in the design of the conversion.

Applicants should also take the opportunity of improving the buildings.

Conversions present the opportunity of extending the original building especially through additional floors. Where an extension increases the height of a block that is already larger than the adjacent buildings, its acceptability will need to be carefully assessed in relation to the surrounding streetscape (refer also to DG32 and DG39).



Office building in East Grinstead BEFORE conversion



Office building in East Grinstead AFTER conversion. Whilst there are still some issues with the public realm treatment the scheme is generally a positive improvement



A sensitive residential conversion of an Art Deco style commercial building incorporating an additional storey

# 10 Building Conversions

## CHECKLIST

### How to use

This table provides a checklist for use by both the applicant and planning officer to check that appropriate consideration has been given to the design of a **building conversion** as part of an application.

**PROCESS:** Have you read, understood and applied the principles set out above?

**PROCESS:** The adjacent table summarises the key principles set out within this section and can be used by applicant and officer as a checklist.

The applicant is expected to meet the requirements of all relevant Principles (ie a tick in each box) or provide a justification for failure to do so.

PRINCIPLE	DESCRIPTION	CHECK
<b>DG53: Traditional Building Conversion</b>	Does the proposed conversion retain the integrity and appearance of the original building, and its defining architectural characteristics?	
	Has a structural report been submitted (where appropriate) to demonstrate that the building is capable of conversion without substantial rebuilding or extension?	
	Has the conversion used the existing openings in elevations for windows and doors? New windows or doors should be added sparingly and should not significantly alter the overall proportion of solid wall to openings. A simple window design is usually most appropriate.	
	If additional floors are introduced, do they avoid cutting across tall windows? Do internal subdivision of the buildings respond sensitively to internal architectural details (eg ornate timberwork and plasterwork)?	
	Does the landscaping, boundary treatments and access roads reflect the character of the site and setting?	
<b>DG54: Office to Residential Conversion</b>	Does the conversion remodel the existing buildings so that it responds to the prevailing streetscape / townscape?	
	Does the conversion adequately respond to challenges in respect of daylighting, natural ventilation, thermal performance and servicing?	
	Does the proposal provide appropriate amenity, parking and storage?	

**Accessibility** - The ability of people to move around an area and to reach places and facilities, including elderly and disabled people, and those with young children.

**Active frontage** - Refers to street frontages where there is an active visual engagement between those in the street and those on the ground and upper floors of buildings.

**Building line** - The line formed by the frontages of buildings along a street or space.

**Bulk** - The combined effect of the arrangement, volume and shape of a building or group of buildings. Also called massing.

**Character assessment** - An area appraisal identifying distinguishing physical features and emphasising historical and cultural associations.

**Coarse grain** – refer to urban grain – the areas pattern is coarse grain where the street blocks, street junctions and spaces between buildings tend to be large.

**Context** - The setting of a site or area, including factors such as traffic, activities and land uses as well as landscape and built form.

**Defensible space** – Space around a building that is defensible in the sense that it is surveyed, demarcated and maintained by somebody.

**Density** - The floorspace of a building or buildings or some other unit measure in relation to a given area of land. Built density is expressed in number of dwellings per hectare (for residential development) in this guide.

**Desire line** - An imaginary line directly linking facilities or places which people find convenient to travel between easily.

**Distinctiveness** - The positive features of a place and its communities which contribute to its special character and sense of place

**Elevation** - The facade of a building, or the drawing of a façade.

**Enclosure** -The use of buildings to create a sense of defined space.

**Fenestration** - The arrangement of windows on a facade.

**Fine grain** - refer to urban grain – the areas pattern is fine grain where the streets and spaces are tight knit and feature narrower building frontages, smaller blocks and more frequent junctions.

**Human scale** - Development which relates well in size and design to an individual human being and is assembled in a way which makes people feel comfortable rather than overwhelmed.

**Landmark** - A building or physical feature that stands out from its background by virtue of height, size or some other aspect of design.

**Layout** - The way buildings, routes and open spaces are placed in relation to each other.

**Legibility** - The degree to which a place can be easily understood and navigated.

**Massing** - The combined effect of the height, bulk and silhouette of a building or group of buildings.

**Natural surveillance** - The discouragement of anti-social activity by the presence of passers-by or the ability of people to be seen out of surrounding windows. Also known as passive surveillance.

**Node** - A place where activity and routes are concentrated often used as a synonym for junction.

**Permeability** - The degree to which an area has a variety of pleasant, convenient and safe routes through it.

**Public art** - Permanent or temporary physical work of art visible to the general public, whether part of a building or free-standing: can include sculpture, lighting effects, street furniture, paving, railings and signs.

**Public realm** - The parts of a village, town or city (whether publicly or privately owned) that are available, without charge, for everyone to use or, see, including streets, squares and parks.

**Scale** - The impression of a building when seen in relation to its surroundings, or the size of parts of a building or its details, particularly as experienced in relation to the size of a person (also refer to 'human scale'). Sometimes it is the total dimensions of a building which give it its sense of scale; at other times it is the size of the elements and the way they are combined.

**Settlement pattern** - The distinctive way that the roads, paths and buildings are laid out in a particular place.

**Sight line** - Lines of clear, uninterrupted sight from a viewer's location to other locations and distances.

**Strategic view** - The line of sight from a particular point to an important landmark or skyline.

**Street furniture** - Structures in and adjacent to the highway which contribute to the streetscape, such as bus shelters, litter bins, seating, lighting, railings and signs.

**Streetscape** - The visual character of a street space that results from the combination of street width, curvature, paving, street furniture, plantings and the surrounding built form and detail. The people and activities present in the street also contribute to the streetscape.

**Sustainability** - Meeting the needs of the present without compromising the ability of future generations to meet their needs.

**Traffic calming** - Measures taken to slow or reduce vehicle traffic and improve safety for pedestrians and cyclists.

**Topography** - The physical shape, form and surface configuration of an area including the slope of the land and features such as rivers.

**Urban design** - The art of making places. Urban design involves the design of buildings, groups of buildings, spaces and landscapes, in villages, towns and cities, and the establishment of frameworks and processes which facilitate successful development.

**Urban grain** - The pattern of the arrangement and size of buildings and their plots in a settlement; and the degree to which an area's pattern of street-blocks and street junctions is respectively small and frequent, or large and infrequent.

**Vernacular** - The way in which ordinary buildings were built in a particular place making use of local styles, techniques and materials and responding to local economic and social conditions.

